

LUKE

GROUP

FIBROPLAST

CATÁLOGO RODOVIÁRIO

Great
Place
To
Work®



Edição
2023

CATÁLOGO RODOVIÁRIO

FIBROPLAST

 LUKE GROUP

10
ANOS

FIBROPLAST

LUKE GROUP

O seu jeito, o seu caminhão.

ACESSÓRIOS PARA CAMINHÕES LUKE FIBROPLAST

TECNOLOGIAS

Aqui você vai encontrar uma vasta gama de acessórios que tornam o seu caminhão perfeito para as suas tarefas de transporte - e também para a sua personalidade. Desenvolvemos uma linha completa de acessórios, para que seja possível aumentar o conforto, a funcionalidade e a segurança da linha pesada. Nossos produtos são desenvolvidos com os mais altos padrões de qualidade, testados e aprovados em situações reais, sem danificar outras partes do veículo e mantendo suas características originais.



SEGURANÇA

Anti-furto: protege todos os degraus do estribo do caminhão com a porta fechada, evitando desta maneira o acesso à cabine durante a viagem.

ESTÉTICA

Capas/Envoltentes: substituem ou envolvem o parachoque original, dando um visual diferenciado ao caminhão, deixando-o mais robusto.



ECONOMIA

Aerofólios e cegonheiros: melhoram a aerodinâmica do caminhão, economizando pneus e combustível.

Acesse: www.lukefibroplast.com.br
e veja mais detalhes dos nossos produtos.

FUNCIONALIDADES

Spoilers: instalado no parachoque do caminhão, deixando-o mais largo, contando com vantagens estéticas e na aerodinâmica frontal, cortando a corrente de ar que passa abaixo do caminhão e possibilita também a instalação de iluminação auxiliar que ajuda na visibilidade e segurança.

Quebra-sol: protegem dos raios solares diretos, conferindo beleza e funcionalidade ao caminhão.

Tampa Estribos: tampa apenas um degrau do estribo do caminhão, podendo ser usado para guardar o calçado do motorista durante a viagem.

MAIS TECNOLOGIA E INOVAÇÃO PARA O SEU CAMINHÃO.

Somos uma indústria de acessórios e peças para caminhões leves e pesados. Dispomos das mais altas tecnologias de transformação de plásticos e fibras. Nossa história começou em 2012 com uma estrutura de 2000 m², hoje contamos com uma estrutura aperfeiçoada de 10000 m² e colaboradores capazes de produzir mais de 1000 peças diárias com qualidade e padrão Luke.

Estamos em constante aprimoramento do processo produtivo para nos mantermos sempre alinhados às tendências e necessidades do mercado.

Além disso, reunimos nossa equipe para mapear e atender diferentes feedbacks, sugestões e críticas para oferecer um trabalho cada vez mais eficiente e que atenda às diferentes demandas dos nossos clientes. Esse catálogo foi planejado para que todos os clientes vejam de perto os nossos produtos. Cada peça é apresentada por meio de fotos, identificação e demais informações necessárias. Assim, é possível encontrar a peça certa, com mais facilidade e objetividade.

LEMBRE-SE:

- Todas as imagens de produtos aqui apresentadas, são meramente ilustrativas.
- Os produtos da marca Luke Fibroplast são originais e possuem registro.
- As marcas citadas neste catálogo são de propriedade exclusiva dos fabricantes dos veículos e implementos, ou seja, não nos responsabilizamos pelas mesmas.
- Qualquer produto pode ser alterado ou substituído sem aviso prévio.

Estamos à disposição para ajudá-lo e esclarecer toda e qualquer dúvida relacionada aos nossos produtos.

NOSSO CATÁLOGO POSSUI QR-CODES PARA FACILITAR O ACESSO AO NOSSO SITE, APONTE A CÂMERA DO SEU CELULAR E APROVEITE ESSA FACILIDADE.

TECNOLOGIAS



RTM LIGHT RESIN TRANSFER MOLDING

Consiste na construção da peça com mantas de fibra de vidro de alta performance e injeção de resina com auxílio de vácuo, o que permite acabamento em ambos os lados das peças.



SPRAY UP

O processo de laminação consiste em aplicar resina e fibra de vidro na superfície de um molde e em seguida utilizam-se roletes metálicos para eliminação de bolhas de ar, feita em molde aberto.



PEÇAS PERSONALIZADAS

Para atender às demandas do mercado, oferecemos uma estrutura que possibilita a entrega de peças pintadas na cor escolhida, conseguindo atender de maneira eficiente e com qualidade superior, podendo inclusive, oferecer a personalização de frotas de caminhões, contribuindo com rapidez e profissionalismo, agregando valor aos nossos produtos.

VANTAGENS

FIDELIDADE DE COR DEVIDO À PROCESSOS COM TECNOLOGIA DE PONTA

OFERTA DE CORES NACIONAIS E IMPORTADAS

MAIS DE 2000 CORES ORGANIZADAS PELAS 15 MONTADORAS

ECONOMIA DE TINTA, MÃO DE OBRA E TEMPO



VACCUM FORMING

Processo que usa a termoformagem para fabricação de produtos termoplásticos, somando a materiais de alto desempenho.



METALÚRGICA

Processo de transformação de metais, como corte, dobra, solda, pintura, entre outros, permitindo a produção de todos os nossos suportes e fixadores e uma gama enorme de produtos.



PROJETOS PERSONALIZADOS

Oferecemos a possibilidade de desenvolvimento de projetos sob demanda, com nossos mais de 10 anos de experiência, para desenvolver soluções variadas em produtos, processos e ferramental, atendendo diversos segmentos como linha moveleira, entre outras.

Traga seu projeto para a Luke Fibroplast e tenha uma solução moderna e inteligente.

VANTAGENS

EXPERIÊNCIA EM DIVERSOS RAMOS

TIME DE DESENVOLVIMENTO

ESTRUTURA DE PRODUÇÃO PARA DIVERSAS DEMANDAS

SOLUÇÕES DE ALTO DESEMPENHO.

NOSSA ESTRADA É OFERECER

UMA PARCERIA DE CONFIANÇA.

Somos uma indústria de acessórios e peças para caminhões leves e pesados. Dispomos das mais altas tecnologias de transformação de plásticos e fibras. Nossa história começou em 2012 com uma estrutura de 2000 m², hoje contamos com uma estrutura aperfeiçoada de 10000 m² e colaboradores capazes de produzir 1000 peças diárias com qualidade e padrão altamente pronto para instalar nos caminhões.

LUKE

GROUP

FIBROPLAST



SUMÁRIO

GERAL

DAF

| | |
|------------------|----|
| DEFLETORES | 12 |
| TAMPA ESTRIBOS | 13 |
| SIDE SKIRT | 13 |
| TAMPA DE BATERIA | 13 |
| DIVERSOS | 13 |



FORD

| | |
|-------------------|-------|
| DEFLETORES | 17 |
| ANTI-FURTOS | 17 |
| TAMPA ESTRIBOS | 17 |
| QUEBRA-SOL | 18 |
| SPOILERS | 18/19 |
| PARA-CHOQUES | 19 |
| ESTRIBOS | 20 |
| GRADES | 21 |
| TAMPA DE BATERIAS | 21 |
| DIVERSOS | 21/22 |



IVECO

| | |
|-------------------|-------|
| DEFLETORES | 27/28 |
| TAMPA ESTRIBOS | 28 |
| SPOILERS | 29 |
| SIDE SKIRT | 29 |
| PARA-CHOQUES | 30 |
| ESTRIBOS | 30 |
| TAMPA DE BATERIAS | 31 |
| DIVERSOS | 31/32 |



MERCEDES-BENZ

| | |
|-------------------|-------|
| DEFLETORES | 39/42 |
| ANTI FURTOS | 42/43 |
| TAMPA ESTRIBOS | 43 |
| QUEBRA-SOL | 44 |
| SPOILERS | 44/46 |
| SIDE SKIRT | 47 |
| PARA-CHOQUES | 47/48 |
| ESTRIBOS | 48/50 |
| GRADES | 50 |
| TAMPA DE BATERIAS | 50/51 |
| PARALAMAS | 51 |
| DIVERSOS | 51/52 |



SCANIA

| | |
|-------------------|-------|
| DEFLETORES | 58/60 |
| ANTI-FURTOS | 61 |
| SIDE SKIRT | 61 |
| TAMPA ESTRIBO | 62 |
| QUEBRA-SOL | 62 |
| PARA-CHOQUES | 63/64 |
| GRADES | 65 |
| TAMPA DE BATERIAS | 65 |
| DIVERSOS | 65 |



MAN

| | |
|------------|----|
| DEFLETORES | 68 |
| SPOILERS | 68 |



VOLKSWAGEN

| | |
|-------------------|-------|
| DEFLETORES | 74/75 |
| ANTI-FURTOS | 75 |
| SIDE SKIRT | 75 |
| TAMPA ESTRIBOS | 75 |
| QUEBRA-SOL | 76 |
| SPOILERS | 76/77 |
| PARA-CHOQUES | 77/78 |
| ESTRIBOS | 78 |
| GRADES | 79 |
| TAMPA DE BATERIAS | 79 |
| DIVERSOS | 79/81 |



VOLVO

| | |
|--------------------|-------|
| DEFLETORES | 86/87 |
| ANTI-FURTOS | 88 |
| SIDE SKIRT | 88/89 |
| DEFLETOR DE COLUNA | 89 |
| TAMPA ESTRIBOS | 89 |
| SPOILERS | 89/91 |
| QUEBRA-SOL | 91 |
| PARA-CHOQUES | 92 |
| ESTRIBOS | 93 |
| GRADES | 93 |
| TAMPA DE BATERIAS | 93 |
| DIVERSOS | 94 |
| PARALAMAS | 95 |
| PROTETORES | 95 |



RENAULT

| | |
|------------|----|
| DEFLETORES | 96 |
|------------|----|





GALERIA DAF

lukefibroplast.com.br/produto/listar/Daf

NEW DAF XF - SPACE CAB
NEW DAF XF - SUPER SPACE CAB
DAF XF 105 - SUPER SPACE CAB.
DAF XF 105 - SPACE CAB.
NEW DAF CF - SPACE CAB
NEW DAF CF RÍGIDO - CAB. BAIXA

DAF

DEFLETORES

NEW DAF XF - SPACE CAB
NEW DAF XF - SUPER SPACE CAB
DAF XF 105 - SUPER SPACE CAB.
DAF XF 105 - SPACE CAB.
NEW DAF CF SPACE CAB.
NEW DAF CF RÍGIDO - CAB. BAIXA



TAMPA ESTRIBOS

NEW DAF CF



TAMPA DE BATERIAS

DAF XF 105



SIDE SKIRT

NEW DAF XF
NEW DAF CF



SPOILERS

SPOILER DAF XF 105
SPOILER NEW DAF XF
NEW DAF CF



DIVERSOS

NEW DAF XF
DAF XF





01 AEROFÓLIO NEW DAF XF -
SPACE CAB. - LAT. RETRÁTIL
COD:26708



01 CEGONHEIRO NEW DAF XF
- SPACE CAB. C/ TETO - LAT.
RETRÁTIL
COD:26718



01 CEGONHEIRO NEW DAF
XF - SPACE CAB. - LAT.
RETRÁTIL
COD:26717



02 SPOILER NEW DAF XF
APÓS 2020
COD: 5089



03 ALONGADOR PARALAMA
NEW DAF XF
COD: 26731



04 SIDE SKIRT NEW DF XF -
ENTRE EIXO 3475MM
COD: 5661



04 SIDE SKIRT NEW DF XF
ENTRE EIXO 3.600 MM
COD: 5664





DEFLETORES

DAF



CÓD: 26708

Descrição: AEROFÓLIO NEW DAF XF - SPACE CAB. - LAT. RETRÁTIL
Componente: Plástico



CÓD: 26717

Descrição: CEGONHEIRO NEW DAF XF - SPACE CAB. - LAT. RETRÁTIL
Componente: Plástico



CÓD: 26718

Descrição: CEGONHEIRO NEW DAF XF - SPACE CAB. C/ TETO - LAT. RETRÁTIL
Componente: Plástico



CÓD: 26719

Descrição: AEROFÓLIO NEW DAF XF - SUPER SPACE CAB. - LAT. RETRÁTIL
Componente: Plástico



CÓD: 19981

Descrição: CEGONHEIRO DAF XF 105 - SPACE CAB.
Componente: Plástico



CÓD: 19722

Descrição: AEROFÓLIO DAF XF 105 - SPACE CAB.
Componente: Plástico



CÓD: 19856

Descrição: CEGONHEIRO DAF XF 105 - SPACE CAB. C/ TETO
Componente: Plástico



CÓD: 5667

Descrição: AEROFÓLIO NEW DF CF SPACE CAB.
Componente: Plástico



CÓD: 5679

Descrição: CEGONHEIRO NEW DF CF SPACE CAB. SEM TETO
Componente: Plástico



CÓD: 5933

Descrição: CEGONHEIRO NEW DF CF SPACE CAB. COM TETO
Componente: Plástico

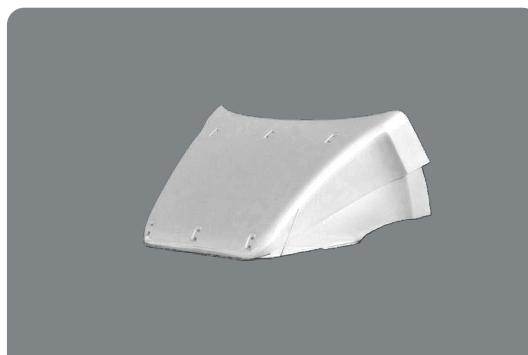

CÓD: 6965

Descrição: AEROFÓLIO PARCIAL NEW DAF CF RÍGIDO - CAB. BAIXA
Componente: Plástico



CÓD: 6966

Descrição: AEROFÓLIO CPL NEW DAF CF RÍGIDO - CAB. BAIXA
Componente: Plástico

TAMPA ESTRIBOS

DAF

CÓD: 5672

Descrição: TAMPA-ESTRIBO NEW DF CF
Componente: Plástico



TAMPA DE BATERIA SIDE SKIRT

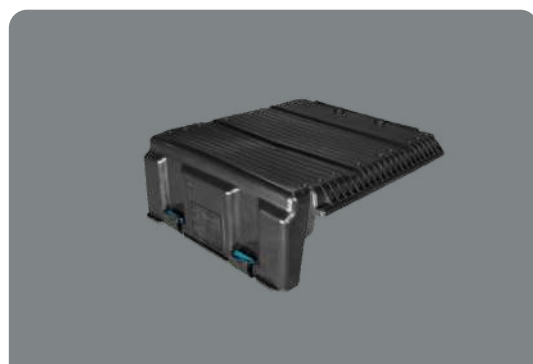

CÓD: 5990

Descrição: TAMPA DE BATERIA DAF XF 105
Componente: Plástico
Referência: 1693114

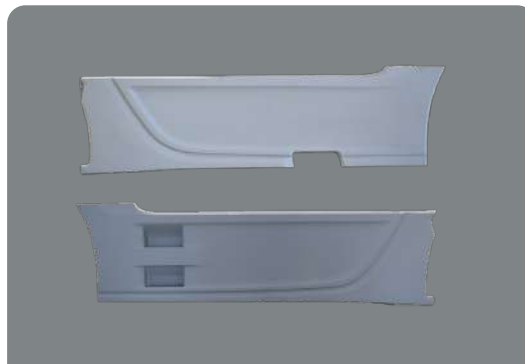

CÓD: 5661

Descrição: SIDE SKIRT NEW DF XF 6x4 - E.E. 3475MM
Componente: Plástico

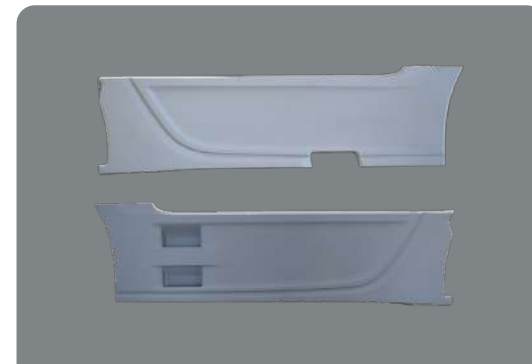

CÓD: 5664

Descrição: SIDE SKIRT NEW DAF XF 6x2 - E.E. 3600MM
Componente: Plástico

SPOILERS

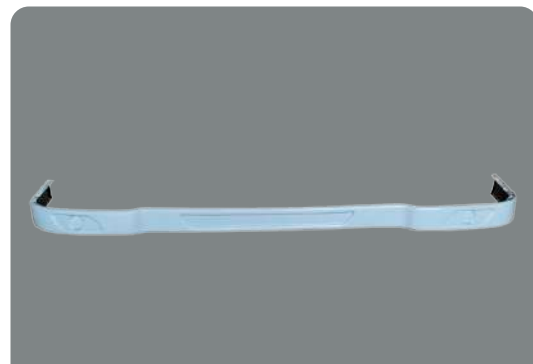

CÓD: 5089

Descrição: SPOILER NEW DAF XF APÓS 2020
Componente: Plástico

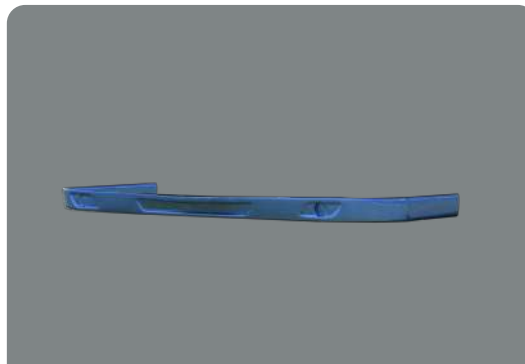

CÓD: 5668

Descrição: SPOILER NEW DF CF
Componente: Plástico

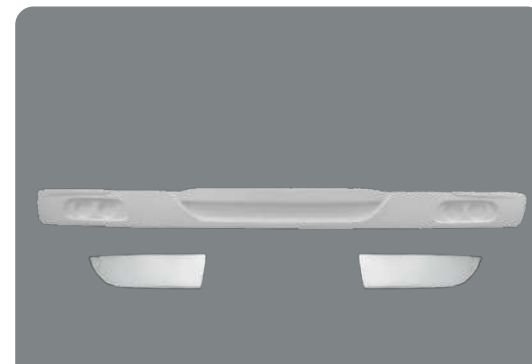

CÓD: 19918

Descrição: SPOILER DAF XF 105
Componente: Plástico

DIVERSOS



CÓD: 5675

Descrição: ALONGADOR DE PARALAMA NEW DF CF
Componente: Plástico



CÓD: 26731

Descrição: ALONGADOR PARALAMA NEW DAF XF
Componente: Plástico



CÓD: 5946

Descrição: CALHA DE PORTA DAF XF
Componente: Plástico



GALERIA FORD

lukefibroplast.com.br/produto/listar/Ford

FORD CARGO CAB. BAIXA
FORD CARGO CAB. ALTA
FORD CARGO EXTRA PESADO
FORD CARGO CAB. SIMPLES

FORD

DEFLETORES

FORD-CARGO 2012 CABINA ALTA
 FORD-CARGO 2012 CABINA BAIXA
 FORD-CARGO ATÉ 2010 - 1119-816S
 FORD-CARGO EXTRA PESADO 2014
 FORD-CARGO 2012 LEITO/ALTA



ESTRIBOS

FORD-CARGO 815
 FORD-CARGO 2622 TRAÇADO
 FORD-CARGO MOD. 2012
 FORD-CARGO 2422/1722/2428 até 2011



ANTI-FURTOS

FORD-CARGO 1119-816-S
 FORD-CARGO 2012



GRADES

FORD-CARGO NOVO 1723/2429/2629
 FORD-CARGO ATÉ 2011



TAMPA ESTRIBOS

FORD-CARGO 2012



TAMPA DE BATERIAS

FORD-CARGO 715-815 1996 2007
 FORD-CARGO APÓS 2011



QUEBRA-SOL

FORD-CARGO 2012 CAB. BAIXA/SIMPLES
 FORD-CARGO 2012 CAB. ALTA
 FORD-CARGO ATÉ 2011 - 816-1119



DIVERSOS

FORD-CARGO
 FORD-CARGO 2422E 2428E 1722E 2622E
 FD CARGO ELET. APÓS 2011
 FORD-CARGO APÓS 2011



SPOILERS

FORD-CARGO 2422
 FORD-CARGO 815
 FORD-CARGO ATÉ 99
 FORD-CARGO 1119-816
 FORD-CARGO 1622-2422 ATÉ 2011
 FORD-CARGO 2012
 FORD-CARGO TRAÇADO 2012



PARA-CHOQUES

FORD CARGO 1723/2429 APOS 2011
 FORD-CARGO 815/712
 FORD-CARGO 2622-2628 TRAÇADO
 FORD-CARGO 2422/1722/2428





01 AEROFÓLIO PARCIAL
FORD-CARGO 2012 LEITO/
ALTA C/ REG
COD:17067

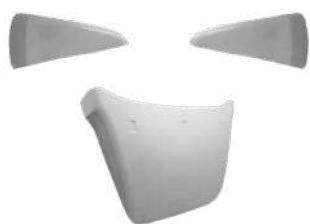

01 AEROFÓLIO FORD-CARGO
2012 CABINA BAIXA
COD:16545



01 AEROFÓLIO FORD-CARGO
2012 CABINA ALTA
COD:16544



02 ANTI-FURTO FORD-CARGO
2012 C/ AMORTECEDOR
COD:16464

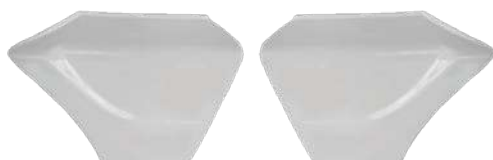

02 TAMPA ESTRIBO 01 DEGRAU
FORD-CARGO 2012
COD:17026



03 QUEBRA-SOL FORD-CARGO
2012 CAB. BAIXA/SIMPLES
COD:15783



03 QUEBRA-SOL FORD-CARGO
2012 CAB. ALTA
COD:16465



04 CAPÔ FORD-CARGO NOVO
1723/2429/2629
COD:19332



05 PARACHOQUE FORD CARGO
1723/2429 APOS 2011



DEFLETORES

FORD



CÓD: 16544

Descrição: AEROFÓLIO FORD-CARGO 2012 CABINA ALTA
Componente: Plástico



CÓD: 16545

Descrição: AEROFÓLIO FORD-CARGO 2012 CABINA BAIXA
Componente: Plástico



CÓD: 18777

Descrição: AEROFÓLIO FORD-CARGO ATÉ 2010 - 1119-816S
Componente: Plástico



CÓD: 25121

Descrição: AEROFÓLIO PARCIAL FORD-CARGO ATÉ 2010 - 1119-816S
Componente: Plástico



CÓD: 18778

Descrição: AEROFÓLIO FORD-CARGO EXTRA PESADO 2014
Componente: Plástico



CÓD: 17067

Descrição: AEROFÓLIO PARCIAL FORD-CARGO 2012 LEITO/ALTA C/ REG
Componente: Plástico

ANTI-FURTOS



CÓD: 18678

Descrição: ANTI-FURTO FORD-CARGO 1119-816-S
Componente: Plástico



CÓD: 16464

Descrição: ANTI-FURTO FORD-CARGO 2012 C/ AMORTECEDOR
Componente: Plástico

TAMPA ESTRIBOS



CÓD: 17026

Descrição: TAMPA ESTRIBO 01 DEGRAU
FORD-CARGO 2012
Componente: Plástico

QUEBRA-SOL

FORD



SPOILERS

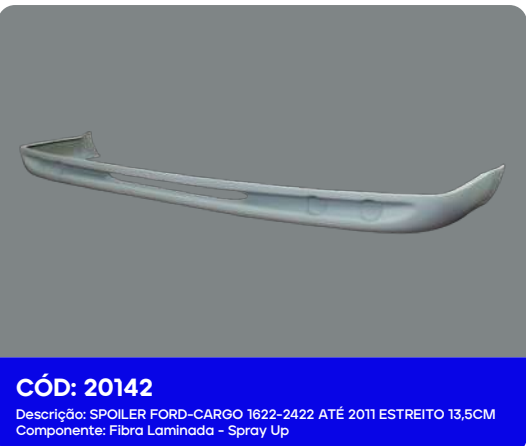

SPOILERS

FORD



PARA-CHOQUES



ESTRIBOS

FORD



CÓD: 3652
 Descrição: ESTRIBO L.E. FORD-CARGO 815
 Componente: Fibra Laminada - Spray Up
 Referência: 8C456820046AAXWA



CÓD: 3654
 Descrição: ESTRIBO L.D. FORD-CARGO 815
 Componente: Fibra Laminada - Spray Up
 Referência: 8C456820046AAXWA



CÓD: 3990
 Descrição: ESTRIBO L.E. FORD-CARGO 2622 TRAÇADO
 Componente: Fibra Laminada - Spray Up
 Referência: 8C456820046CAYBC



CÓD: 3991
 Descrição: ESTRIBO L.D. FORD-CARGO 2622 TRAÇADO
 Componente: Fibra Laminada - Spray Up
 Referência: 8C456820046CAYBC



CÓD: 15884
 Descrição: ESTRIBO L.E. FORD-CARGO MOD. 2012
 Componente: Fibra Laminada - Spray Up
 Referência: 8C456820046BBXWA



CÓD: 15883
 Descrição: ESTRIBO L.D. FORD-CARGO MOD. 2012
 Componente: Fibra Laminada - Spray Up
 Referência: 8C456820046BBXWA



CÓD: 19440
 Descrição: ESTRIBO FORD-CARGO L.E. 2422/1722/2428 até 2011 RTM
 Componente: Fibra Injetada - RTM
 Referência: 5C456820046CXWA



CÓD: 19441
 Descrição: ESTRIBO FORD-CARGO L.D. 2422/1722/2428 até 2011 RTM
 Componente: Fibra Injetada - RTM
 Referência: 5C456820046CXWA



CÓD: 26577
 Descrição: ESTRIBO FORD-CARGO L.E. 2422/1722/2428 até 2011 PLÁST
 Componente: Plástico
 Referência: 5C456820046CXWA

CÓD: 26578
 Descrição: ESTRIBO FORD-CARGO L.D. 2422/1722/2428 ATÉ 2011 PLÁST
 Componente: Plástico
 Referência: 5C456820046CXWA



GRADES

FORD

CÓD: 19332

Descrição: CAPÔ FORD-CARGO NOVO 1723/2429/2629
 Componente: Fibra Injetada - RTM
 Referência: BC4516610ABXWA



CÓD: 19442

Descrição: GRADE FORD-CARGO ABERTA ATÉ 2011 RTM
 Componente: Fibra Injetada - RTM
 Referência: 1C458C300ACXWA



TAMPA DE BATERIAS



CÓD: 15752

Descrição: TAMPA DE BATERIA FORD-CARGO 715-815 1996 2007
 Componente: Plástico
 Referência: XC4510A687AA



CÓD: 24193

Descrição: TAMPA DE BATERIA FORD-CARGO APÓS 2011
 Componente: Plástico
 Referência: 9C4510A687BB

DIVERSOS



CÓD: 15683

Descrição: PISANTE DO ESTRIBO FORD-CARGO 2° PISO 02 DEGRAUS L.E.
 Componente: Plástico
 Referência: 1C4516490BB



CÓD: 15684

Descrição: PISANTE DO ESTRIBO FORD-CARGO 2° PISO 02 DEGRAUS L.D.
 Componente: Plástico
 Referência: 1C4516491BB



CÓD: 15685

Descrição: PISANTE DO ESTRIBO FORD-CARGO 1° PISO + 815 L.E.
 Componente: Plástico
 Referência: 1C4516490AB



CÓD: 5991
 Descrição: SUPORTE DE PLACA FORD-CARGO APÓS 2011
 Componente: Plástico
 Referência: BC4513406A





GALERIA IVECO

lukefibroplast.com.br/produto/listar/iveco

- IVECO HI-WAY
- IVECO CAVALLINO
- IVECO DAILY
- IVECO EURO CARGO
- IVECO EUROTECH
- IVECO STRALIS
- IVECO TECTOR
- IVECO CURSOR

IVECO

DEFLETORES

IVECO HI-WAY CABINA BAIXA
 IVECO HI-WAY CABINA ALTA
 IVECO EUROTECH CABINA BAIXA
 IVECO CAVALLINO
 IVECO STRALIS CABINA BAIXA 2008
 IVECO STRALIS CABINA ALTA
 IVECO DAILY
 IVECO DAILY 2008 EM DIANTE
 IVECO TECTOR CABINA SIMPLES
 IVECO TECTOR LEITO CABINA BAIXA
 IVECO TECTOR CABINA ALTA



PARA-CHOQUES

IVECO EUROTECH
 IVECO STRALIS
 IVECO STRALIS HD 380
 IVECO TECTOR/CURSOR



ESTRIBOS

IVECO STRALIS
 IVECO EUROTECH



TAMPA ESTRIBOS

IVECO TECTOR-CURSOR
 IVECO STRALIS



TAMPA DE BATERIAS

IVECO EUROTECH/STRALIS
 IVECO EUROTECH



SPOILERS

IVECO STRALIS AP
 IVECO STRALIS HD
 IVECO HI-WAY
 IVECO TECTOR
 IVECO TECTOR/CURSOR



DIVERSOS

IVECO STRALIS
 IVECO TECTOR



SIDE SKIRT

IVECO HI-WAY





01 CEGONHEIRO COM TETO
IVECO HI-WAY CABINA ALTA
COD:17848



02 SPOILER IVECO HI-WAY
MOD. ORIGINAL - L.E.
COD:19520



02 SPOILER IVECO HI-WAY
MOD.ORIGINAL
COD: 19519

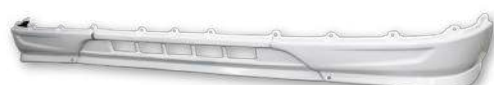

01 AEROFÓLIO IVECO HI-WAY
CABINA BAIXA
COD:26346



02 SPOILER IVECO HI-WAY
MOD. ORIGINAL - CENTRO
COD: 19522



03 SIDE SKIRT IV HI-WAY
6X2 - EE 3500MM
COD: 6258



01 CEGONHEIRO IVECO HI-WAY
COM TETO CABINA BAIXA
COD:26381



02 SPOILER IVECO HI-WAY MOD.
ORIGINAL - L.D.
COD: 19521



03 SIDE SKIRT IV HI-WAY
6X4 - EE 3500MM
COD: 6672





DEFLETORES

IVECO



DEFLETORES

IVECO



TAMPA ESTRIBOS



SPOILERS

IVECO



SIDE SKIRT



PARA-CHOQUES

IVECO

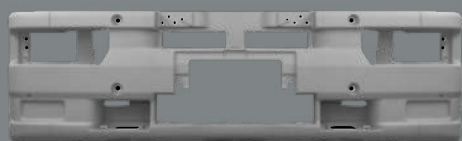

CÓD: 20581

Descrição: PARACHOQUE IVECO EUROTECH
Componente: Fibra Laminada - Spray Up
Referência: 2997104



CÓD: 4002

Descrição: PARACHOQUE IVECO STRALIS APÓS 2008 (TODOS)
Componente: Fibra Injetada - RTM
Referência: 504284316M 500383947



CÓD: 20584

Descrição: PARACHOQUE IVECO STRALIS HD 380
Componente: Plástico
Referência: 504103112

CÓD: 19913

Descrição: PARACHOQUE IVECO
TECTOR/CURSOR
Componente: Fibra Laminada - Spray Up
Referência: 504281899

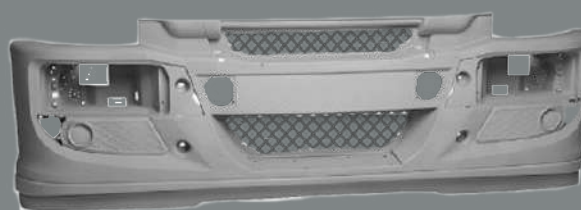

ESTRIBOS



CÓD: 4017

Descrição: ESTRIBO IVECO STRALIS 2008 - L.E. RTM FUNDO PU
Componente: Fibra Injetada - RTM
Referência: 500375430



CÓD: 4018

Descrição: ESTRIBO IVECO STRALIS 2008 - L.D. RTM FUNDO PU
Componente: Fibra Injetada - RTM
Referência: 500375431



CÓD: 20328

Descrição: ESTRIBO IVECO STRALIS 2008 - L.E. RTM PRETO
Componente: Fibra Injetada - RTM
Referência: 500375430



CÓD: 20329

Descrição: ESTRIBO IVECO STRALIS 2008 - L.D. RTM PRETO
Componente: Plástico
Referência: 500375431



CÓD: 20582

Descrição: ESTRIBO IVECO EUROTECH L.E.
Componente: Fibra Laminada - Spray Up
Referência: 98417358



CÓD: 20583

Descrição: ESTRIBO IVECO EUROTECH L.D.
Componente: Fibra Laminada - Spray Up
Referência: 98417357

TAMPA DE BATERIAS

IVECO



DIVERSOS



DIVERSOS

IVECO



CÓD: 5997

Descrição: TAMPÃO GRADE FRONTAL IVECO STRALIS
Componente: Plástico
Referência: 504171044



CÓD: 5998

Descrição: ACABAMENTO SUP. ESTRIBO L.E. IVECO STRALIS
Componente: Plástico
Referência: 504001358



CÓD: 5999

Descrição: ACABAMENTO SUP. ESTRIBO L.D. IVECO STRALIS
Componente: Plástico
Referência: 504001361



CÓD: 6000

Descrição: ACABAMENTO INF. ESTRIBO L.E. IVECO STRALIS
Componente: Plástico
Referência: 504001344



CÓD: 6001

Descrição: ACABAMENTO INF. ESTRIBO L.D. IVECO STRALIS
Componente: Plástico
Referência: 504001345



CÓD: 15877

Descrição: TAMPÃO PARACHOQUE STRALIS 2008
Componente: Plástico
Referência: 504187339

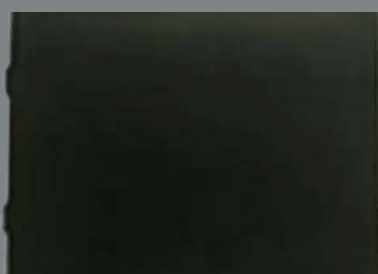

CÓD: 15882

Descrição: TAMPÃO PARACHOQUE STRALIS 2008
Componente: Plástico
Referência: 504187294



CÓD: 15879

Descrição: TAMPÃO RETAN. DO PARACHOQUE STRALIS L.E.
Componente: Plástico
Referência: 504187427

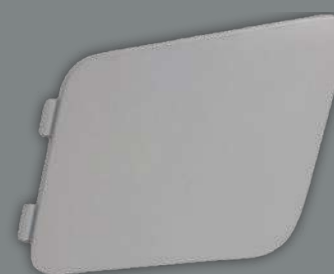

CÓD: 15878

Descrição: TAMPÃO RETAN. DO PARACHOQUE STRALIS L.D.
Componente: Plástico
Referência: 504187426



CÓD: 15881

Descrição: TAMPÃO DO FAROL L.E. STRALIS
Componente: Plástico
Referência: 504187507



CÓD: 15880

Descrição: TAMPÃO DO FAROL L.D. STRALIS
Componente: Plástico
Referência: 504187506





GALERIA MERCEDES-BENZ

lukefibroplast.com.br/produto/listar/Mercedes-benz

MERCEDES ATEGO
MERCEDES AXOR
MERCEDES ATRON
MERCEDES ACCELO
MERCEDES SPRINTER
MERCEDES NEW ACTROS
MERCEDES ACTROS MEGASPACE
MERCEDES CARA PRETA

MERCEDES-BENZ

DEFLETORES

MB NEW ACTROS
 MB ACTROS CABINA ALTA
 MB ACTROS CABINA BAIXA
 MB ACTROS MEGASPACE
 MB SPRINTER
 MB ATEGO CABINE BAIXA/ALTA
 MB ATEGO CABINE SIMPLES
 MB ATEGO CABINE ALTA
 MB ATEGO/AXOR CABINA SIMPLES
 MB AXOR CABINA ALTA
 MB AXOR CABINA BAIXA
 MB AXOR 3131-3344-4144 TRAÇADO
 MB ACCELO 2018 CAB. ESTENDIDA
 MB ACCELO
 MB 1635-1634-1935
 MB SPRINTER 2013
 MB ATRON 2729 1718 1720 1318 FRONTAL
 MB ATRON 2324-710-1620-1720



QUEBRA SOL

MB ATEGO/AXOR CAB. BAIXA
 MB ATRON 1635 ATEGO/AXOR
 MB ACCELO
 MB 1618-1620 ATRON 1319-1719-2324-2729
 MB CARA PRETA



SPOILERS

MB AXOR
 MB AXOR 1933
 MB AXOR 2540
 MB ACTROS
 MB NEW ACTROS
 MB ATEGO
 MB ATEGO 2430
 MB ACCELO 1016
 MB CARA PRETA 1114 -1313
 MB 1113 ANTIGO
 MB 912 -914C-1318-1718
 MB 1934 LS
 MB 1935/1941
 MB 1938 LS
 MB 1620
 MB 1618
 MB ATRON-1635 LS
 MB 709-710 712
 MB 709-710



ANTI-FURTOS

MB AXOR 2540-2644
 MB AXOR 1933
 MB 1113-1313-1513 "CARA PRETA"
 MB 1620 / ATRON 2324
 MB ATEGO
 MB NEW ACTROS



TAMPA ESTRIBOS

MB ACTROS
 MB AXOR 2540
 MB AXOR 1933
 MB AXOR 2831-3131 TRAÇADO
 MB AXOR 2540
 MB AXOR 3344-4144 TRAÇADO
 MB 1938S/1944S
 MB 1113-1313-1513 "CARA PRETA"
 MB1620 / 1938 LS / ATRON



SIDE SKIRT

MB NEW ACTROS



MERCEDES-BENZ

PARA-CHOQUES

MB 1935/1941 LS
 MB 1720/1723
 MB 712/914/1318/1215
 MB 709-710-710-912
 MB 1938 LS
 MB ATRON 1635 LS
 MB 1634 LS
 MB AXOR 2540, 2544
 MB AXOR
 MB ATEGO



TAMPA DE BATERIAS

MB LS 1938-1634-1935
 MB 915-712C-710-1935
 MB 709-1418-1618
 MB L1218 L1620 1634
 MB AXOR
 MB AXOR APÓS 2012 + ATRON EURO 5
 MB ACTROS ORION



ESTRIBOS

MB AXOR 1933
 MB AXOR 2540
 MB ATEGO
 MB 1720
 MB 1935/1634 LS
 MB 1620



PARALAMAS

MB ATEGO



GRADES

MB 1620 MOD. 1938 LS
 MB 1620
 MB 1620/1938



DIVERSOS

MB AXOR/1938S/1944S
 MB ACTROS 2021
 MB BICUDO 1620 1938 1634 1635
 MB 1720 FRONTAL
 MB ATEGO/AXOR 1938S
 MB ACCELO
 MB 1634 ELET.
 MB 1218-1634-1720-1935
 MB 1938-LS-1634
 MB 1938-S
 MB 1620
 MB 1620-1728
 MB 1618-1418-1718
 MB 1418-1618-1630-1935
 MB 1618-1418-1718
 MB 1620/1938/1634
 MB AXOR







01 AEROFÓLIO MB NEW ACTROS
COD: 5783



01 AEROFÓLIO MB NEW ACTROS -
LAT. RETRÁTIL
COD: 9528



01 CEGONHEIRO MB NEW ACTROS
C/ TETO
COD: 5649



01 CEGONHEIRO MB NEW ACTROS
C/ TETO E LATERAL LARGA
COD: 9525

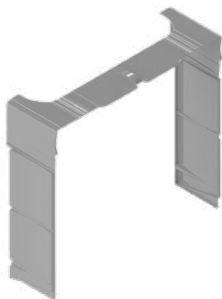

02 SIDE SKIRT MB NEW ACTROS
6X2 / 6X4 EURO 5
COD: 9526



02 SIDE SKIRT MB NEW ACTROS 4X2
EURO 5
COD: 9527



03 ANTI-FURTO MB NEW ACTROS
COD: 26710



04 SPOILER MB NEW ACTROS
COD: 5765



DEFLETORES

MERCEDES-BENZ

CÓD: 5649

Descrição: CEGONHEIRO MB NEW ACTROS C/ TETO
Componente: Plástico



CÓD: 5783

Descrição: AEROFÓLIO MB NEW ACTROS
Componente: Plástico



CÓD: 9528

Descrição: AEROFÓLIO MB NEW ACTROS - LAT. RETRÁTIL
Componente: Plástico

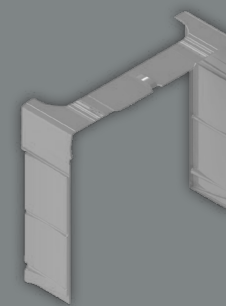

CÓD: 9525

Descrição: CEGONHEIRO MB NEW ACTROS C/ TETO E LATERAL LARGA
Componente: Plástico



CÓD: 20726

Descrição: CEGONHEIRO MB ACTROS CABINA ALTA - FILTRO RECORTADO
Componente: Plástico



CÓD: 17959

Descrição: CEGONHEIRO MB ACTROS CABINA ALTA SEM TETO
Componente: Plástico



CÓD: 23572

Descrição: CEGONHEIRO MB ACTROS CABINA ALTA COM TETO
Componente: Plástico



CÓD: 23573

Descrição: CEGONHEIRO MB ACTROS CABINA ALTA COM TETO - FILTRO RECORTADO
Componente: Plástico



CÓD: 23630

Descrição: AEROFÓLIO MB ACTROS CAB. ALTA
Componente: Plástico



CÓD: 23631

Descrição: AEROFÓLIO MB ACTROS CAB. ALTA - FILTRO RECORTADO
Componente: Plástico

DEFLETORES

MERCEDES-BENZ



DEFLETORES

MERCEDES-BENZ



CÓD: 26385
 Descrição: CEGONHEIRO MB ATEGO CAB. SIMPLES S/TETO
 Componente: Plástico



CÓD: 17964
 Descrição: AEROFÓLIO CPL MB ATEGO/AXOR CABINA SIMPLES TETO FIXO
 Componente: Plástico

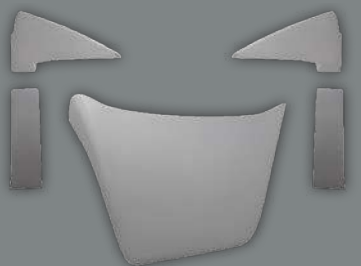

CÓD: 4013
 Descrição: AEROFÓLIO MB ATEGO/AXOR C/ REG. CAB. SIMPLES 05 PARTES
 Componente: Plástico



CÓD: 17963
 Descrição: AEROFÓLIO PARCIAL MB ATEGO/AXOR CABINA SIMPLES TETO FIXO
 Componente: Plástico



CÓD: 19908
 Descrição: CEGONHEIRO MB AXOR CABINA ALTA C/ TETO
 Componente: Plástico



CÓD: 16777
 Descrição: CEGONHEIRO MB AXOR CABINA ALTA
 Componente: Plástico



CÓD: 17137
 Descrição: AEROFÓLIO MB AXOR CABINA ALTA
 Componente: Plástico



CÓD: 17154
 Descrição: AEROFÓLIO MB AXOR CABINA BAIXA
 Componente: Plástico



CÓD: 16079
 Descrição: CEGONHEIRO MB AXOR CABINA BAIXA
 Componente: Plástico



CÓD: 20712
 Descrição: AEROFÓLIO MB AXOR 3131-3344-4144 TRAÇADO CPL
 Componente: Plástico



CÓD: 24503
 Descrição: AEROFÓLIO MB ACCELO 2018 CAB. ESTENDIDA CPL
 Componente: Plástico



CÓD: 24289
 Descrição: AEROFÓLIO MB ACCELO 2018 CAB. ESTENDIDA PARCIAL
 Componente: Plástico

DEFLETORES

MERCEDES-BENZ



CÓD: 24818

Descrição: CEGONHEIRO MB ACCELO 2018 CAB. ESTENDIDA
Componente: Plástico



CÓD: 17153

Descrição: AEROFÓLIO MB ACCELO PARCIAL
Componente: Plástico



CÓD: 17152

Descrição: AEROFÓLIO MB ACCELO CPL
Componente: Plástico

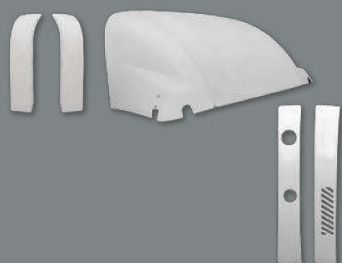

CÓD: 19518

Descrição: AEROFÓLIO MB ACCELO CPL - FILTRO INFERIOR
Componente: Plástico



CÓD: 16779

Descrição: AEROFÓLIO MB 1635-1634-1935
Componente: Plástico



CÓD: 17962

Descrição: AEROFÓLIO CPL MB ATRON 2729 1718 1720 1318 FRONTAL TETO FIXO
Componente: Plástico

CÓD: 17961

Descrição: AEROFÓLIO PARCIAL MB ATRON 2324-710-1620-1720 TETO FIXO
Componente: Plástico



ANTI-FURTOS

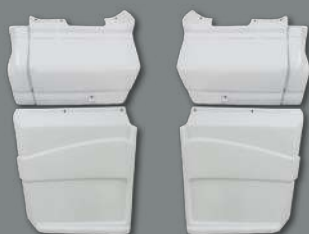

CÓD: 17953

Descrição: ANTI-FURTO MB AXOR 2540-2644
Componente: Plástico



CÓD: 17051

Descrição: ANTI-FURTO MB AXOR 1933
Componente: Plástico



CÓD: 17849

Descrição: ANTI-FURTO MB 1113-1313-1513 "CARA PRETA"
Componente: Plástico

ANTI-FURTOS



TAMPA ESTRIBOS



QUEBRA-SOL

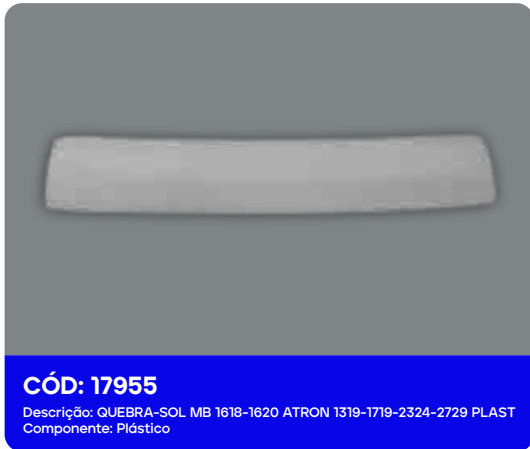

SPOILERS



SPOILERS

MERCEDES-BENZ

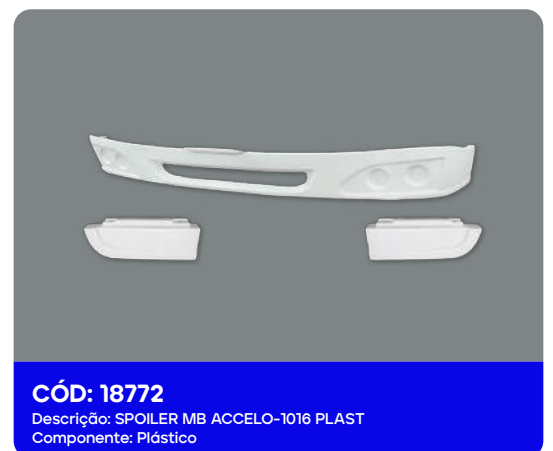

SPOILERS

MERCEDES-BENZ

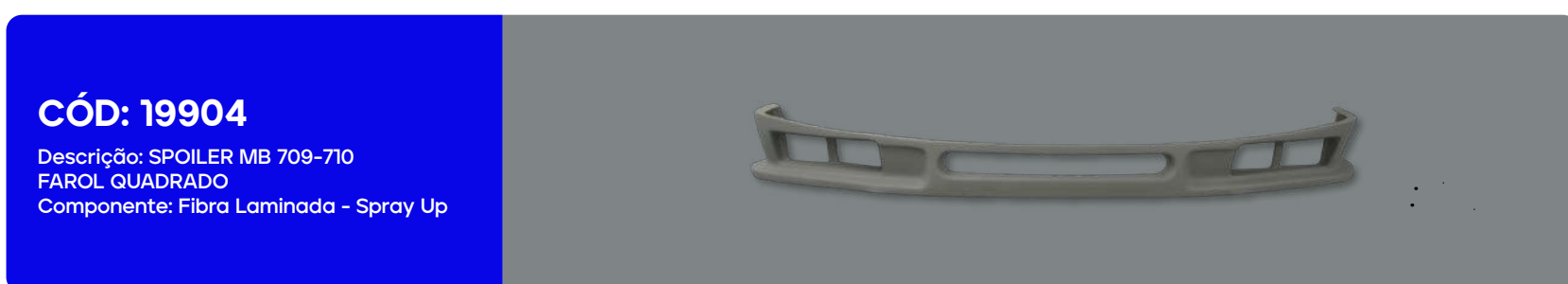

SIDE SKIRT

MERCEDES-BENZ



PARA-CHOQUES

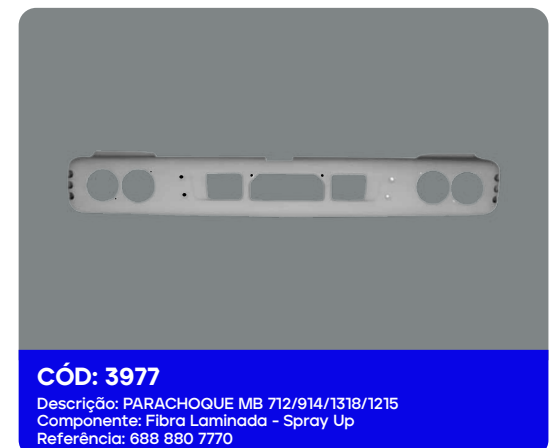

PARA-CHOQUES



CÓD: 6046

Descrição: PONTEIRA L.D. PARACHOQUE MB ATEGO 2012...
Componente: Plástico
Referência: 958 880 8370



CÓD: 6045

Descrição: PONTEIRA L.E. PARACHOQUE MB ATEGO 2012...
Componente: Plástico
Referência: 958 880 8270

MERCEDES-BENZ

ESTRIBOS



CÓD: 19896

Descrição: ESTRIBO L.D. MB AXOR 1933 RTM COR ORIGINAL
Componente: Fibra Injetada - RTM
Referência: 940 666 0901



CÓD: 19895

Descrição: ESTRIBO L.E. MB AXOR 1933 RTM COR ORIGINAL
Componente: Fibra Injetada - RTM
Referência: 940 666 0801



CÓD: 3985

Descrição: ESTRIBO L.D. MB AXOR 1933 RTM FUNDO PU
Componente: Fibra Injetada - RTM
Referência: 940 666 0901



CÓD: 3984

Descrição: ESTRIBO L.E. MB AXOR 1933 RTM FUNDO PU
Componente: Fibra Injetada - RTM
Referência: 940 666 0801



CÓD: 19894

Descrição: ESTRIBO L.D. MB AXOR 2540 RTM COR ORIGINAL
Componente: Fibra Injetada - RTM
Referência: 958 660 1401



CÓD: 19893

Descrição: ESTRIBO L.E. MB AXOR 2540 RTM COR ORIGINAL
Componente: Fibra Injetada - RTM
Referência: 958 660 1301



CÓD: 19444

Descrição: ESTRIBO L.D. MB AXOR 2540 RTM FUNDO PU
Componente: Fibra Injetada - RTM
Referência: 958 660 1401



CÓD: 19443

Descrição: ESTRIBO L.E. MB AXOR 2540 RTM FUNDO PU
Componente: Fibra Injetada - RTM
Referência: 958 660 1301



CÓD: 25735

Descrição: ESTRIBO L.E. MB AXOR 2540 2013 EM DIANTE RTM FUNDO PU
Componente: Fibra Injetada - RTM
Referência: 958 660 2701

ESTRIBOS

MERCEDES-BENZ



CÓD: 25736
 Descrição: ESTRIBO L.D. MB AXOR 2540 2013 EM DIANTE RTM FUNDO PU
 Componente: Fibra Injetada - RTM
 Referência: 958 660 2801



CÓD: 25737
 Descrição: ESTRIBO L.E. MB AXOR 2540 2013 EM DIANTE COR ORIGINAL
 Componente: Fibra Injetada - RTM
 Referência: 958 660 2701



CÓD: 25738
 Descrição: ESTRIBO L.D. MB AXOR 2540 2013 EM DIANTE COR ORIGINAL
 Componente: Fibra Injetada - RTM
 Referência: 958 660 2801



CÓD: 26595
 Descrição: ESTRIBO L.E. MB AXOR 2540 PLÁST.
 Componente: Plástico
 Referência: 958 660 2701



CÓD: 26596
 Descrição: ESTRIBO L.D. MB AXOR 2540 PLÁST.
 Componente: Plástico
 Referência: 958 660 2801



CÓD: 15597
 Descrição: PARALAMA/ESTRIBO MB ATEGO L.D.
 Componente: Fibra Laminada - Spray Up
 Referência: 9586600601



CÓD: 15596
 Descrição: PARALAMA/ESTRIBO MB ATEGO L.E.
 Componente: Fibra Laminada - Spray Up
 Referência: 9586600602



CÓD: 15534
 Descrição: ESTRIBO MB 1720 - L.E. - c/ pisante
 Componente: Fibra Laminada - Spray Up
 Referência: 6936600301



CÓD: 15533
 Descrição: ESTRIBO MB 1720 - L.D. c/ pisante
 Componente: Fibra Laminada - Spray Up
 Referência: 6936600401



CÓD: 3992
 Descrição: PARALAMA DO ESTRIBO L.E MB 1938/1634 LS
 Componente: Fibra Laminada - Spray Up
 Referência: 696 880 0107



CÓD: 3993
 Descrição: PARALAMA DO ESTRIBO L.D MB 1938/1634 LS
 Componente: Fibra Laminada - Spray Up
 Referência: 696 880 0207



CÓD: 16338
 Descrição: PARALAMA DO ESTRIBO L.E. MB 1620
 Componente: Plástico
 Referência: 6948800007

ESTRIBOS

MERCEDES-BENZ

CÓD: 16337

Descrição: PARALAMA DO ESTRIBO L. D. MB 1620
Componente: Plástico
Referência: 6948800107



GRADES



CÓD: 15075

Descrição: GRADE SUPERIOR MB 1620
Componente: Plástico



CÓD: 15359

Descrição: GRADE SUPERIOR MB 1620 mod.1938 LS c/ cromados instalados
Componente: Plástico
Referência: 694 880 0085



CÓD: 15070

Descrição: FRISOS CROMADOS GRADE SUP. MB 1620/1938
Componente: Plástico

CÓD: 15071

Descrição: ESTRELA CROMADA GRADE SUP.
MB 1620/1938
Componente: Plástico



TAMPA DE BATERIAS



CÓD: 15724

Descrição: TAMPA DE BATERIA DUPLA MB LS 1938-1634-1935
Componente: Plástico
Referência: 3845417803



CÓD: 15725

Descrição: TAMPA DE BATERIA MB 915-712C-710-1935
Componente: Plástico
Referência: 3885417303

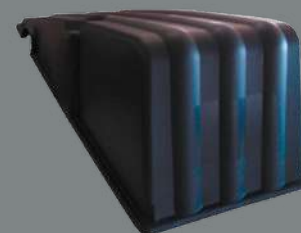

CÓD: 15726

Descrição: TAMPA DE BATERIA MB 709-1418-1618
Componente: Plástico
Referência: 3845417903



CÓD: 15727

Descrição: TAMPA DE BATERIA MB L1218 L1620 1634
Componente: Plástico
Referência: 6955417103

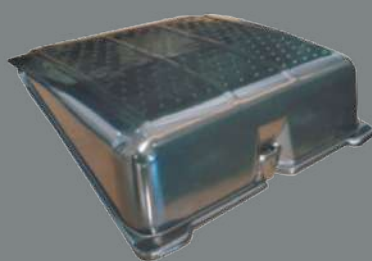

CÓD: 16339

Descrição: TAMPA DE BATERIA MB AXOR
Componente: Plástico
Referência: 9415410103



CÓD: 24191

Descrição: TAMPA DE BATERIA MB ATEGO
Componente: Plástico
Referência: 9585410103

TAMPA DE BATERIAS

MERCEDES-BENZ



CÓD: 24192

Descrição: TAMPA DE BATERIA MB AXOR APÓS 2012 + ATRON EURO 5
Componente: Plástico
Referência: A958541003



CÓD: 5928

Descrição: TAMPA DE BATERIA MB ACTROS ORION 2016 ATE 2020
Componente: Plástico
Referência: A9585410203

PARALAMAS

CÓD: 26382

Descrição: PARALAMA TRASEIRO
MB ATEGO ESQ/DIR
Componente: Plástico
Referência: 9585210201



DIVERSOS

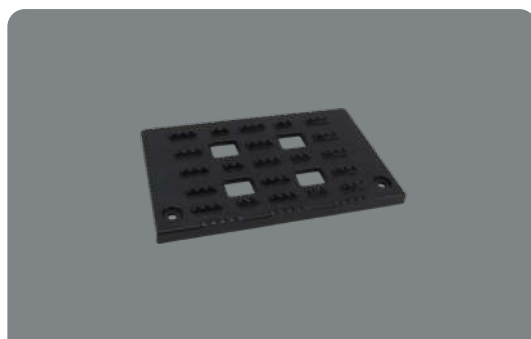

CÓD: 25741

Descrição: PISANTE DO ESTRIBO INFERIOR MB AXOR/1938S/1944S PLÁST.
Componente: Plástico
Referência: 958 666 1028

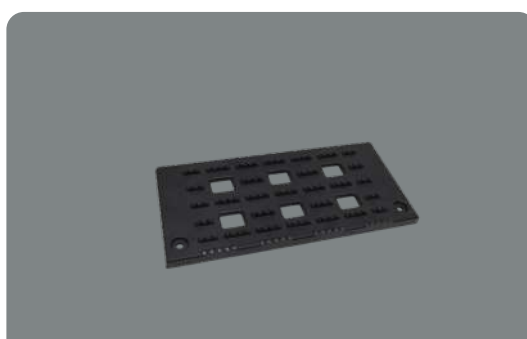

CÓD: 25742

Descrição: PISANTE DO ESTRIBO SUPERIOR MB AXOR/1938S/1944S PLÁST.
Componente: Plástico
Referência: 958 666 0928



CÓD: 5947

Descrição: CALHA DE PORTA MB ACTROS 2021
Componente: Plástico



CÓD: 5949

Descrição: CALHA DE PORTA MB BICUDO 1620/1938/1634/1635 E 1720 FRONTAL
Componente: Plástico



CÓD: 5950

Descrição: CALHA DE PORTA MB ATEGO/AXOR/1938S
Componente: Plástico



CÓD: 5948

Descrição: CALHA DE PORTA MB ACELO INTEIRA
Componente: Plástico

CÓD: 15721

Descrição: DEFLETOR DE RADIADOR 1634 ELET.
Componente: Plástico
Referência: 6955050055



CÓD: 15714

Descrição: SUPORTE DE PLACA MB 1218-1620-1634-1720-1935
Componente: Plástico
Referência: 6938857014



CÓD: 15715

Descrição: DEFLETOR DE RADIADOR PLÁSTICO 1938-LS-1634
Componente: Plástico
Referência: 6965057055



CÓD: 15716

Descrição: DEFLETOR DE RADIADOR PLÁSTICO 1938-S
Componente: Plástico
Referência: 6935057055



CÓD: 15717

Descrição: DEFLETOR DE RADIADOR PLÁSTICO 1620
Componente: Plástico
Referência: 6955057030



CÓD: 15718

Descrição: DEFLETOR DE RADIADOR PLÁSTICO L 1620-1728
Componente: Plástico
Referência: 6935057730

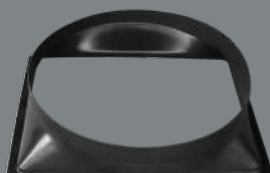

CÓD: 15719

Descrição: DEFLETOR DE RADIADOR PLÁSTICO 1618-1418-1718
Componente: Plástico
Referência: 3845057055



CÓD: 15728

Descrição: MOLDURA FAROL L.D. MB 1418-1618-1630-1935
Componente: Plástico
Referência: 3848817523



CÓD: 15729

Descrição: MOLDURA FAROL L.E. MB 1418-1618-1630-1935
Componente: Plástico
Referência: 3848817423



CÓD: 15885

Descrição: ARREMATE PISCA L.D. 1620/1938/1634
Componente: Plástico
Referência: 6948847274



CÓD: 15886

Descrição: ARREMATE PISCA L.E. 1620/1938/1634
Componente: Plástico
Referência: 6948847174



CÓD: 15890

Descrição: ARO DO FAROL MB AXOR L.D. CROMADO
Componente: Plástico
Referência: 9408851022



CÓD: 15891

Descrição: ARO DO FAROL MB AXOR L.E. CROMADO
Componente: Plástico
Referência: 9408850922







GALERIA SCANIA

lukefibroplast.com.br/produto/listar/Scania

SCANIA NTG CAB. P/G/R

SCANIA CAB. P

SCANIA S4/S5/S6

SCANIA T12/T13 RL-LT

SCANIA CAB. P/G/R

SCANIA STREAMLINE

SCANIA HIGHLINE

SCANIA CAB. BAIXA/ALTA/NORMAL

SCANIA

DEFLETORES

SCANIA NTG - CAB. R NORMAL
 SCANIA NTG - CAB. R ALTA
 SCANIA NTG - CAB. P NORMAL
 SCANIA NTG - CAB. G NORMAL
 SCANIA NTG - CAB. R ALTA
 SCANIA NTG - CAB. G NORMAL
 SCANIA NTG - CAB. P NORMAL
 SCANIA 112/113 LR-LT
 SCANIA 112/113 LR-LT TOP LINE
 SCANIA CAB. G, R
 SCANIA CABINA P
 SCANIA HIGHLINE
 SCANIA S4-S5 CAB. G, R
 SCANIA CAB. P



PARA-CHOQUES

SCANIA S6 P/G/R
 SCANIA S5 2009
 SCANIA S5 2010
 SCANIA 112/113
 SCANIA S4 LR-LT
 SCANIA S4-EVOLUÇÃO
 SCANIA S4 LR-LT-EVOLUÇÃO
 SCANIA STREAMLINE
 SCANIA S4
 SCANIA G/R HIGHLINE
 SCANIA NTG CAB. R
 SCANIA STREAMLINE
 SCANIA LT 113



ANTI-FURTOS

SCANIA S5 cab. P, G, R
 SCANIA S5 2014



GRADES

SCANIA S5/S6 CAB. G/ CAB. P
 SCANIA S5/S6 CAB. R/HIGHLINE
 SCANIA S5



SIDE SKIRT

SC NTG 6X2/6X4



TAMPA DE BATERIAS

SCANIA S5



TAMPA ESTRIBOS

SCANIA 112/113
 SCANIA S5 cab. P
 SCANIA CAB. P 2013
 SCANIA 124 LT
 SCANIA NTG CAB. P
 SCANIA NTG CAB. R



DIVERSOS

SCANIA S5



QUEBRA-SOL

SCANIA S4-S5
 SCANIA NTG





01 AEROFOLIO SC NTG - CAB. R NORMAL
COD: 26006



01 CEGONHEIRO SC C/ TETO NTG - CAB. R ALTA
COD :26497



01 CEGONHEIRO SC S/ TETO NTG - CAB. P NORMAL
COD: 26014



01 CEGONHEIRO SC C/ TETO NTG - CAB. G NORMAL
COD: 26010



02 SIDE SKIRT SC NTG - ENTRE EIXO 3350 MM - ESCAPAMENTO CENTRAL
COD: 26826



03 TAMPA ESTRIBO SCANIA NTG CAB. P
COD:26427



03 TAMPA ESTRIBO SCANIA NTG CAB. R
COD: 26428





DEFLETORES

SCANIA



DEFLETORES

SCANIA



DEFLETORES

SCANIA



CÓD: 15604
 Descrição: AEROFÓLIO CPL SCANIA CAB. P
 Componente: Plástico



CÓD: 15602
 Descrição: AEROFÓLIO CPL SCANIA S4-S5
 Componente: Plástico



CÓD: 15603
 Descrição: AEROFÓLIO CPL SCANIA S5 C/ FILTRO LATERAL
 Componente: Plástico



CÓD: 18032
 Descrição: AEROFÓLIO SCANIA HIGHLINE STREAMLINE
 Componente: Plástico



CÓD: 16787
 Descrição: CEGONHEIRO SCANIA HIGHLINE C/ TETO
 Componente: Plástico



CÓD: 16786
 Descrição: CEGONHEIRO SCANIA HIGHLINE S/ TETO
 Componente: Plástico



CÓD: 16785
 Descrição: CEGONHEIRO SCANIA S4-S5 C/ REC. CAB. G, R C/ TETO
 Componente: Plástico



CÓD: 16789
 Descrição: CEGONHEIRO SCANIA S4-S5 S/ REC. CAB. G, R C/ TETO
 Componente: Plástico



CÓD: 16790
 Descrição: CEGONHEIRO SCANIA S4-S5 S/ REC. CAB. G, R S/ TETO
 Componente: Plástico



CÓD: 17950
 Descrição: AEROFÓLIO SCANIA CABINE P/ LATERAL ESTREITA
 Componente: Plástico

ANTI-FURTOS

SCANIA



SIDE SKIRT



TAMPA ESTRIBOS

SCANIA

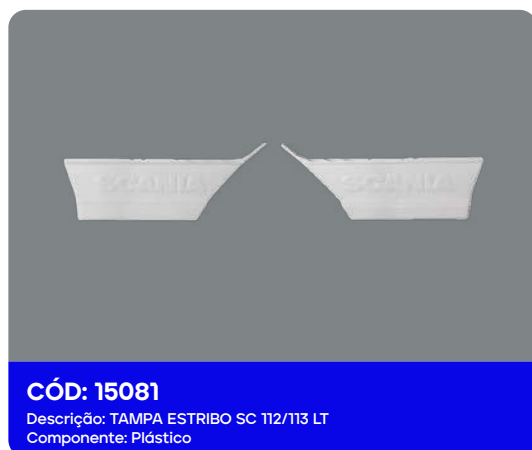

QUEBRA SOL



PARA-CHOQUES

SCANIA



CÓD: 20181
 Descrição: PONTEIRA PC L.D. ORIG. SCANIA S6 P/G/R - LISO
 Componente: Plástico
 Referência: 1884915



CÓD: 20179
 Descrição: CENTRO PC ORIG. SCANIA S6 P/G/R - LISO
 Componente: Plástico
 Referência: 1865181



CÓD: 20180
 Descrição: PONTEIRA PC L.E. ORIG. SCANIA S6 P/G/R - LISO
 Componente: Plástico
 Referência: 1884914



CÓD: 20243
 Descrição: PONTEIRA PC L.D. ORIG. SCANIA S6 P/G/R C/ TEXT+COR
 Componente: Plástico
 Referência: 1884915



CÓD: 20241
 Descrição: CENTRO PC ORIG. SCANIA S6 P/G/R - C/ TEXT+COR
 Componente: Plástico
 Referência: 1865181



CÓD: 20242
 Descrição: PONTEIRA PC L.E. ORIG. SCANIA S6 P/G/R C/ TEXT+COR
 Componente: Plástico
 Referência: 1884914



CÓD: 20178
 Descrição: PARACHOQUE TRI-PARTIDO ORIG. SCANIA S6 P/G/R - LISO
 Componente: Plástico
 Referência: 1865181 1884914 1884915



CÓD: 20239
 Descrição: PARACHOQUE TRI-PARTIDO ORIG. SCANIA S6 P/G/R - C/ TEXT+COR
 Componente: Plástico
 Referência: 1865181-1884914-1884915



CÓD: 20369
 Descrição: CAPA ENVOLVENTE SCANIA STREAMLINE - PLAST 3 PARTES
 Componente: Plástico



CÓD: 20372
 Descrição: CAPA L.D. PARACHOQUE SCANIA STREAMLINE
 Componente: Plástico



CÓD: 20370
 Descrição: CAPA CENTRAL PARACHOQUE SCANIA STREAMLINE
 Componente: Plástico



CÓD: 20371
 Descrição: CAPA L.E. PARACHOQUE SCANIA STREAMLINE
 Componente: Plástico

PARA-CHOQUES

SCANIA

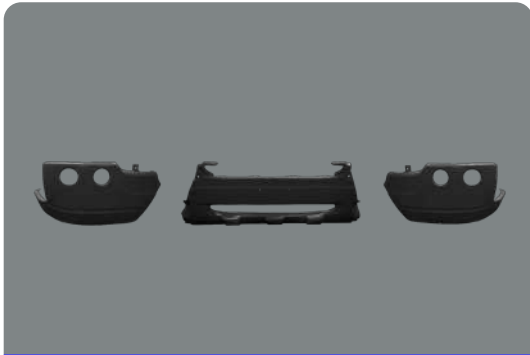

CÓD: 17264

Descrição: CAPA ENVOLVENTE OFF-ROAD SCANIA S5 2010
Componente: Plástico



CÓD: 17150

Descrição: CAPA ENVOLVENTE SCANIA S5 2009
Componente: Plástico



CÓD: 18030

Descrição: CAPA ENVOLVENTE SCANIA S4 LR-LT FAROL QUADRADO
Componente: Plástico



CÓD: 25204

Descrição: CAPA L.D. ENVOLVENTE OFF-ROAD SCANIA S4-EVOLUÇÃO
Componente: Plástico



CÓD: 25203

Descrição: CAPA CENTRAL ENVOLVENTE OFF-ROAD SCANIA S4-EVOLUÇÃO
Componente: Plástico



CÓD: 25205

Descrição: CAPA L.E. ENVOLVENTE OFF-ROAD SCANIA S4-EVOLUÇÃO
Componente: Plástico



CÓD: 20509

Descrição: CAPA ENVOLVENTE OFF-ROAD SCANIA S4-EVOLUÇÃO - PLÁST 3 PARTES
Componente: Plástico

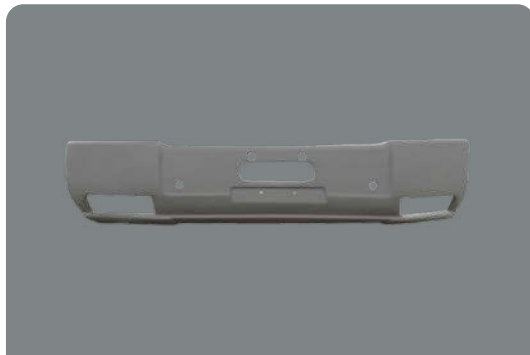

CÓD: 16456

Descrição: PARACHOQUE SCANIA LT 113 CURTO BICUDO ATÉ 93
Componente: Fibra Laminada - Spray Up

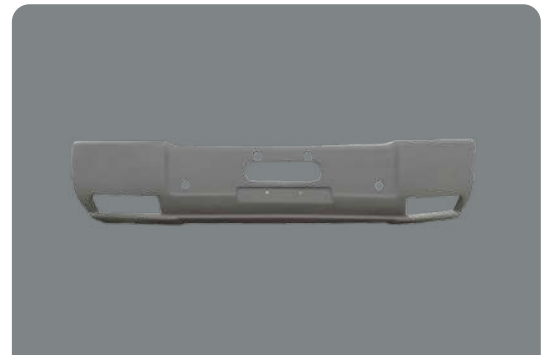

CÓD: 16455

Descrição: PARACHOQUE SCANIA LT 113 LONGO BICUDO APÓS 93
Componente: Fibra Laminada - Spray Up

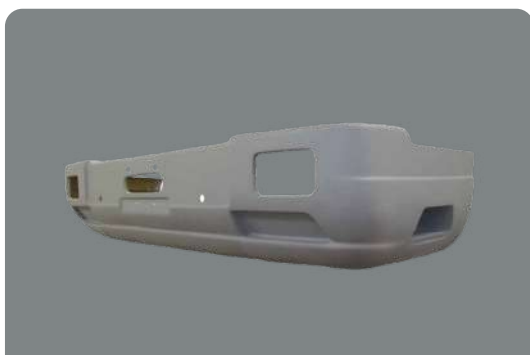

CÓD: 16454

Descrição: PARACHOQUE SCANIA LR 113 FRONTAL C/ FARÓIS ABERTO - C/ SUP
Componente: Fibra Laminada - Spray Up



CÓD: 17262

Descrição: ANTI-DERRAPANTE PARACHOQUE SCANIA 112/113
Componente: Plástico

GRADES

SCANIA



TAMPA DE BATERIAS



DIVERSOS





GALERIA MAN

lukefibroplast.com.br/produto/listar/Man

MAN TGX CABINE ALTA
MAN TGX CABINE BAIXA

MAN

DEFLETORES

MAN TGX CABINA ALTA
MAN TGX CABINA BAIXA



SPOILERS

MAN TGX



01 CEGONHEIRO COM TETO
VW MAN - METEOR
COD:17847



01 AEROFÓLIO MAN TGX -
METEOR CAB. ALTA
COD: 17958



01 CEGONHEIRO VW MAN
TGX - METEOR SEM TETO
COD: 24352



02 SPOILER PARA VW MAN
TGX
COD: 24375



DEFLETORES

MAN



CÓD: 17847

Descrição: CEGONHEIRO C/ TETO MAN TGX - METEOR CAB. ALTA
Componente: Plástico



CÓD: 17958

Descrição: AEROFÓLIO MAN TGX - METEOR CAB. ALTA
Componente: Plástico



CÓD: 20360

Descrição: AEROFÓLIO VW MAN TGX CABINA BAIXA
Componente: Plástico



CÓD: 24352

Descrição: CEGONHEIRO VW MAN TGX - METEOR SEM TETO
Componente: Plástico



SPOILERS

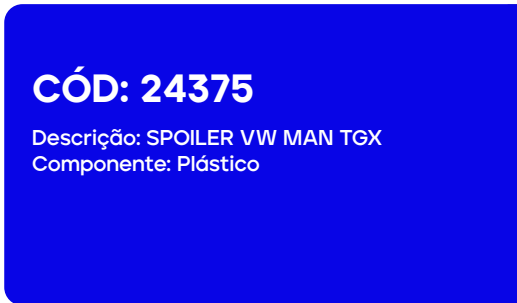

CÓD: 24375

Descrição: SPOILER VW MAN TGX
Componente: Plástico

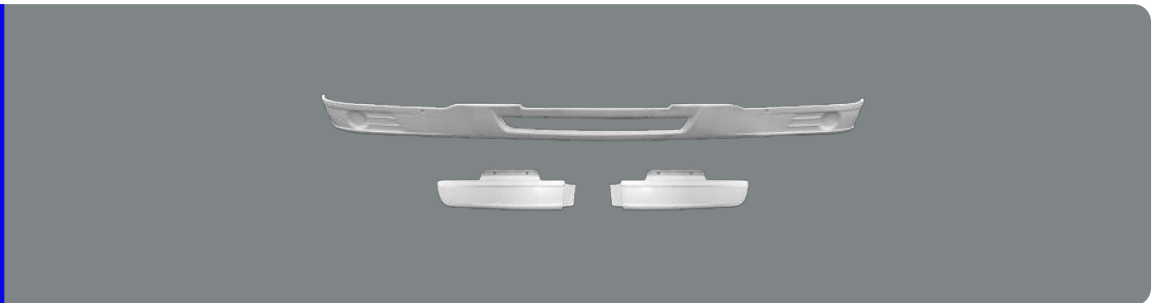





GALERIA VOLKSWAGEN

lukefibroplast.com.br/produto/listar/VW

VOLKSWAGEN METEOR
VOLKSWAGEN DELIVERY
VOLKSWAGEN TITAN
VOLKSWAGEN WORKER
VOLKSWAGEN CONSTELLATION
VOLKSWAGEN MÉDIO/PESADO
VOLKSWAGEN DELIVERY EXPRESS

VOLKSWAGEN

DEFLETORES

VW METEOR
VW 8.150/DELIVERY
VW TITAN-WORKER
VW CONSTELLATION CABINA ALTA
VW CONSTELLATION CABINA BAIXA



ANTI-FURTOS

VW CONSTELLATION
VW METEOR



TAMPA ESTRIBOS

VW CONSTELLATION CABINA BAIXA
VW CONSTELLATION CABINA ALTA



SIDE SKIRT

VW METEOR



QUEBRA SOL

VW WORKER DELIVERY
VW CONSTELLATION CAB. BAIXA
VW DELIVERY



SPOILERS

VW METEOR
VW 14.220 94/99
VW 8.140 94 ATÉ 99
VW 8.150/DELIVERY
VW CONSTELLATION
VW DELIVERY 2013
VW WORKER 17.210
VW WORKER 8.120/8.150
VW CONSTELLATION
VW DELIVERY 2018



PARA-CHOQUES

VW 8.150/DELIVERY
VW 18.310/TITAN
VW 17.120/24.220
VW CONSTELLATION 24.250
VW 8.160/10.160 DELIVERY 2012
VW WORKER 8.120/8.150
VW CONSTELLATION 19.320/19.370
VW 8.160/10.160 DELIVERY 2012



ESTRIBOS

VW METEOR
VW WORKER 23.220/18.310
VW CONSTELLATION 24.250 TETO
BAIXO
VW CONSTELLATION 19.370 TETO
ALTO



GRADES

VW CONSTELLATION
VW METEOR



TAMPA DE BATERIAS

VW LINHA 13-15-17-13-24-26
VW MÉDIO E PESADO
VW CONSTELLATION
VW 7.100-8.140-7.120
VW DELIVERY



DIVERSOS

VW METEOR
VW WORKER
VW CONSTELLATION TETO BAIXO
VW CONSTELLATION TETO ALTO
VW CONSTELLATION
VW DELIVERY
VW DELIVERY EXPRESS
VW CONSTELLATION





01 CEGONHEIRO COM TETO
VW MAN - METEOR
COD:17847



01 AEROFÓLIO MAN TGX -
METEOR CAB. ALTA
COD: 17958



01 CEGONHEIRO VW MAN
TGX - METEOR SEM TETO
COD: 24352



02 ANTI-FURTO VW METEOR
COD: 7863



03 TAMPA ESTRIBO 01 DEGRAU VW
CONSTELLATION CABINA ALTA
COD: 4012



04 GRADE DO PARACHOQUE/
RADIADOR VW METEOR
COD: 7864



05 SIDE SKIRT VW METEOR -
E. E. 3600 MM
COD: 7651



DEFLETORES

VOLKSWAGEN



CÓD: 17847
 Descrição: CEGONHEIRO C/ TETO MAN TGX - METEOR CAB. ALTA
 Componente: Plástico



CÓD: 17958
 Descrição: AEROFÓLIO MAN TGX - METEOR CAB. ALTA
 Componente: Plástico



CÓD: 24352
 Descrição: CEGONHEIRO VW MAN TGX - METEOR SEM TETO
 Componente: Plástico



CÓD: 17949
 Descrição: AEROFÓLIO PARCIAL VW 8.150/DELIVERY TETO FIXO
 Componente: Plástico



CÓD: 17948
 Descrição: AEROFÓLIO CPL VW 8.150 DELIVERY
 Componente: Plástico



CÓD: 18776
 Descrição: AEROFÓLIO CPL VW TITAN-WORKER
 Componente: Plástico



CÓD: 16778
 Descrição: AEROFÓLIO VW CONSTELLATION CABINA ALTA
 Componente: Plástico



CÓD: 16546
 Descrição: AEROFÓLIO VW CONSTELLATION CABINA BAIXA
 Componente: Plástico



CÓD: 16922
 Descrição: CEGONHEIRO VW CONSTELLATION CAB. ALTA
 Componente: Plástico



CÓD: 20507
 Descrição: CEGONHEIRO VW CONSTELLATION CAB. ALTA COM TETO
 Componente: Plástico



CÓD: 16923
 Descrição: CEGONHEIRO VW CONSTELLATION CAB. BAIXA
 Componente: Plástico



CÓD: 23901
 Descrição: AEROFÓLIO CPL VW DELIVERY 2018
 Componente: Plástico

DEFLETORES

VOLKSWAGEN



ANTI-FURTOS



SIDE SKIRT



TAMPA ESTRIBOS



QUEBRA-SOL

VOLKSWAGEN



SPOILERS

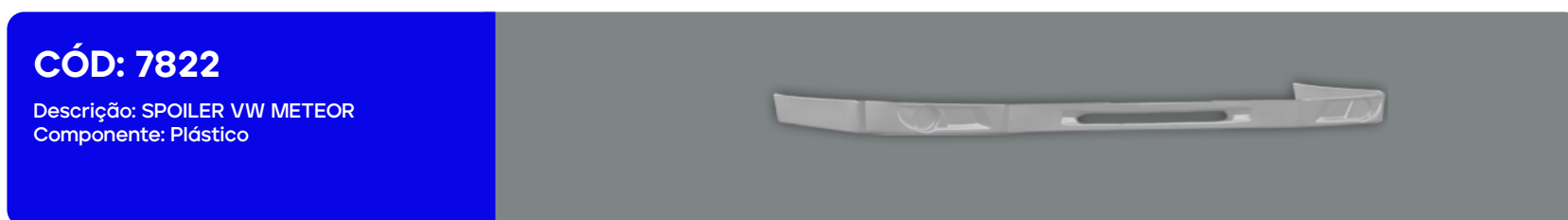

SPOILERS

VOLKSWAGEN



PARA-CHOQUES

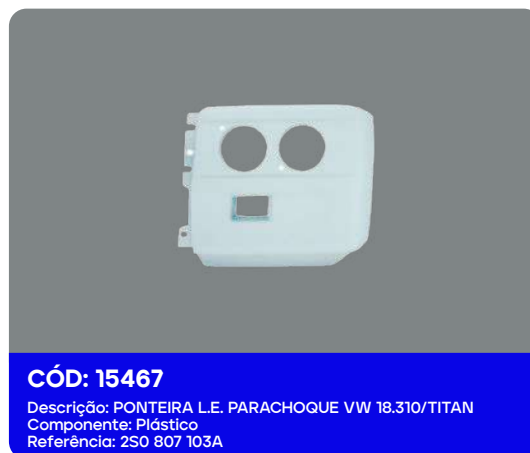
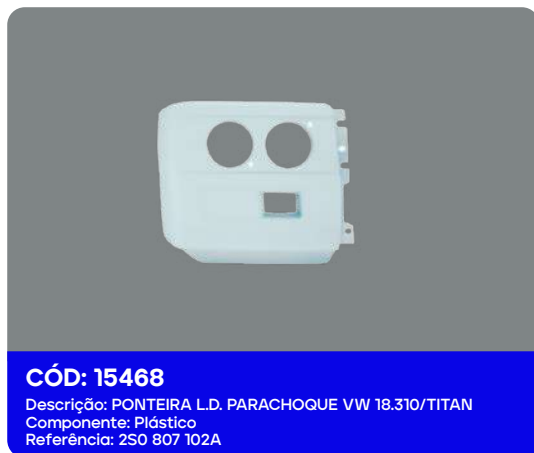
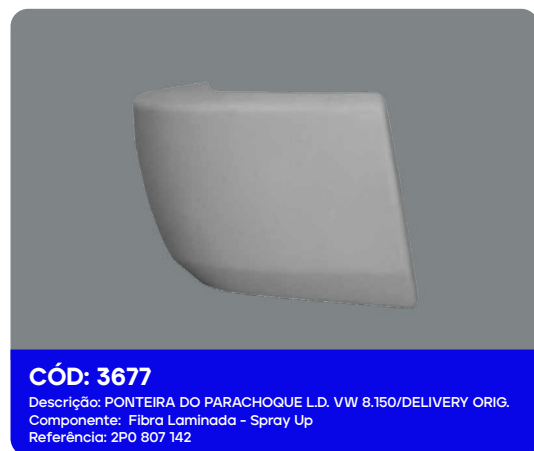

PARA-CHOQUES

VOLKSWAGEN



CÓD: 15474
 Descrição: PONTEIRA L.D. PARACHOQUE VW 13.180/26.220
 Componente: Plástico
 Referência: 250 807 102B



CÓD: 15472
 Descrição: CENTRAL PARACHOQUE VW 13.180/26.220
 Componente: Plástico
 Referência: 2RG 807 105A



CÓD: 15473
 Descrição: PONTEIRA L.E. PARACHOQUE VW 13.180/26.220
 Componente: Plástico
 Referência: 250 807 103B



CÓD: 20248
 Descrição: PONTEIRA DO PARACHOQUE L.D. VW 8.160/10.160 DELIVERY 2012...NOVA
 Componente: Plástico
 Referência: 2PO 807 142B



CÓD: 20246
 Descrição: CENTRAL DO PARACHOQUE VW 8.160/10.160 DELIVERY 2012...NOVA
 Componente: Plástico
 Referência: 2PO 807 103B



CÓD: 20247
 Descrição: PONTEIRA DO PARACHOQUE L.E. VW 8.160/10.160 DELIVERY 2012...NOVA
 Componente: Plástico
 Referência: 2PO 807 141B



CÓD: 20332
 Descrição: PONTEIRA DO PARACHOQUE L.D. VW 8.160/10.160 DELIVERY 2012...NOVA PRETO
 Componente: Plástico
 Referência: 2PO 807 142B



CÓD: 20330
 Descrição: CENTRAL DO PARACHOQUE VW 8.160/10.160 DELIVERY 2012...NOVA PRETO
 Componente: Plástico
 Referência: 2PO 807 103B



CÓD: 20331
 Descrição: PONTEIRA DO PARACHOQUE L.E. VW 8.160/10.160 DELIVERY 2012...NOVA PRETO
 Componente: Plástico
 Referência: 2PO 807 141B



CÓD: 20251
 Descrição: PONTEIRA DO PARACHOQUE L.D. VW WORKER 8.120/8.150
 Componente: Plástico
 Referência: 2RD 807 104



CÓD: 20249
 Descrição: CENTRAL DO PARACHOQUE VW WORKER 8.120/8.150
 Componente: Plástico
 Referência: 2RD 807 105



CÓD: 20250
 Descrição: PONTEIRA DO PARACHOQUE L.E. VW WORKER 8.120/8.150
 Componente: Plástico
 Referência: 2RD 807 103

CÓD: 5757
 Descrição: MOLDURA PARA FAROLETE VW CONSTELLATION 02 DEGRAUS
 Componente: Plástico



PARA-CHOQUES

VOLKSWAGEN



CÓD: 20254

Descrição: PONTEIRA L.D. PARACHOQUE VW CONSTELLATION 19.320/19.370
Componente: Plástico
Referência: 2T2 807 076



CÓD: 20252

Descrição: CENTRAL PARACHOQUE VW CONSTELLATION 19.320/19.370
Componente: Plástico
Referência: 2T2 807 071



CÓD: 20253

Descrição: PONTEIRA L.E. PARACHOQUE VW CONSTELLATION 19.320/19.370
Componente: Plástico
Referência: 2T2 807 075



CÓD: 17054

Descrição: PONTEIRA PARACHOQUE L.D. VW CONSTELLATION 24.250
Componente: Plástico
Referência: 2S2807076N28



CÓD: 17052

Descrição: CENTRAL PARACHOQUE VW CONSTELLATION 24.250
Componente: Plástico
Referência: 2S2807071N28



CÓD: 17053

Descrição: PONTEIRA PARACHOQUE L.E. VW CONSTELLATION 24.250
Componente: Plástico
Referência: 2S2807075N28

ESTRIBOS



CÓD: 9099

Descrição: ESTRIBO INFERIOR VW METEOR L.D.
Componente: Plástico
Referência: 2V3802646D



CÓD: 9101

Descrição: ESTRIBO INFERIOR VW METEOR L.E.
Componente: Plástico
Referência: 2V5802645



CÓD: 15754

Descrição: ESTRIBO L.D. VW CONSTELLATION 24.250 TETO BAIXO
Componente: Fibra Injetada - RTM
Referência: 2S2821648



CÓD: 15755

Descrição: ESTRIBO L.E. VW CONSTELLATION 24.250 TETO BAIXO
Componente: Fibra Injetada - RTM
Referência: 2S2821647



CÓD: 15757

Descrição: ESTRIBO L.D. VW CONSTELLATION 19.370 TETO ALTO
Componente: Fibra Laminada - Spray Up
Referência: 2T2821648



CÓD: 15756

Descrição: ESTRIBO L.E. VW CONSTELLATION 19.370 TETO ALTO
Componente: Fibra Laminada - Spray Up
Referência: 2T2821647

GRADES

VOLKSWAGEN



TAMPA DE BATERIAS

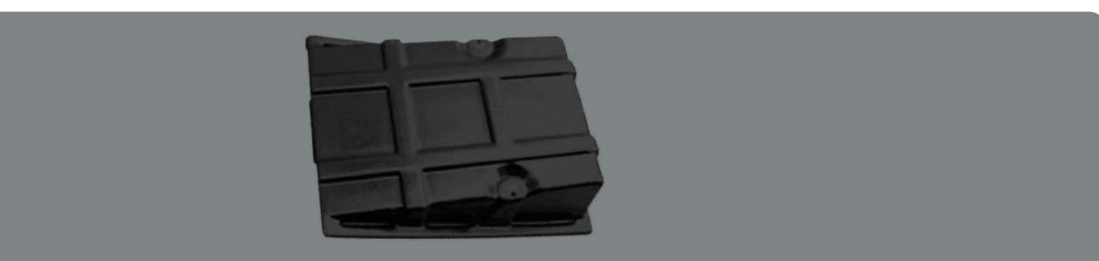

DIVERSOS



DIVERSOS

VOLKSWAGEN



CÓD: 15702
 Descrição: TAPETE PRETO SUPERIOR VW WORKER L.D.
 Componente: Plástico
 Referência: 2VF863736



CÓD: 15703
 Descrição: TAPETE CINZA 2º PISO VW CONSTELLATION TETO BAIXO L.E.
 Componente: Plástico
 Referência: 2S2821685



CÓD: 15704
 Descrição: TAPETE CINZA 2º PISO VW CONSTELLATION TETO BAIXO L.D.
 Componente: Plástico
 Referência: 2S2821686



CÓD: 15705
 Descrição: TAPETE CINZA 1º PISO VW CONSTELLATION TETO BAIXO L.E.
 Componente: Plástico
 Referência: 2S2821681



CÓD: 15706
 Descrição: TAPETE CINZA 1º PISO VW CONSTELLATION TETO BAIXO L.D.
 Componente: Plástico
 Referência: 2S2821682



CÓD: 15707
 Descrição: TAPETE CINZA 1º PISO VW CONSTELLATION TETO ALTO L.E.
 Componente: Plástico
 Referência: 2T2821681



CÓD: 15708
 Descrição: TAPETE CINZA 1º PISO VW CONSTELLATION TETO ALTO L.D.
 Componente: Plástico
 Referência: 2T2821682



CÓD: 15709
 Descrição: TAPETE CINZA 3º PISO VW CONSTELLATION TETO ALTO L.E.
 Componente: Plástico
 Referência: 2T2821687



CÓD: 15710
 Descrição: TAPETE CINZA 3º PISO VW CONSTELLATION TETO ALTO L.D.
 Componente: Plástico
 Referência: 2T2821688



CÓD: 15711
 Descrição: TAPETE CINZA 2º PISO VW CONSTELLATION TETO ALTO L.E.
 Componente: Plástico
 Referência: 2T2821685



CÓD: 15712
 Descrição: TAPETE CINZA 2º PISO VW CONSTELLATION TETO ALTO L.D.
 Componente: Plástico
 Referência: 2T2821686

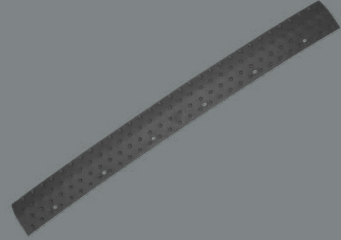

CÓD: 15713
 Descrição: TAPETE CINZA FRONTAL VW CONSTELLATION
 Componente: Plástico
 Referência: 2S2821331

DIVERSOS

VOLKSWAGEN



CÓD: 15739

Descrição: SUPORTE DE PLACA VW CONSTELLATION
Componente: Plástico
Referência: TAP8078014M2

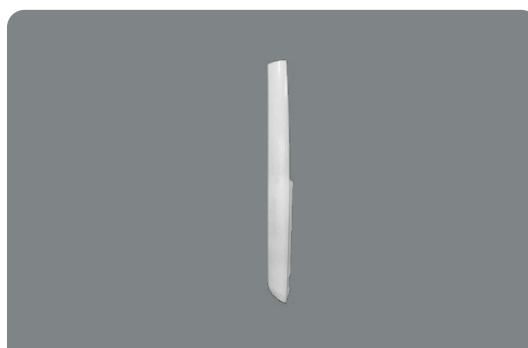

CÓD: 26392

Descrição: COLUNA VW CONSTELLATION L.D. - ORIG.
Componente: Plástico
Referência: 2R2809056A



CÓD: 26391

Descrição: COLUNA VW CONSTELLATION L.E. - ORIG.
Componente: Plástico
Referência: 2R2809055A



CÓD: 26393

Descrição: DEF DE COLUNA VW CONSTELLATION L.E. - PEG
Componente: Plástico
Referência: 2R2809559A



CÓD: 5766

Descrição: DEFLETOR DE COLUNA ESPORTIVO VW CONSTELLATION (TODOS)
Componente: Plástico



CÓD: 26394

Descrição: DEF DE COLUNA VW CONSTELLATION L.D. - PEG.
Componente: Plástico
Referência: 2R2809560A



CÓD: 5932

Descrição: DEFLETOR DE RADIADOR VW DELIVERY EXPRESS
Componente: Plástico
Referência: 121207A



CÓD: 5951

Descrição: CALHA DE PORTA VW DELIVERY 2018
Componente: Plástico



CÓD: 5930

Descrição: DEFLETOR DE RADIADOR VW DELIVERY 9.170
Componente: Plástico
Referência: 23B121207

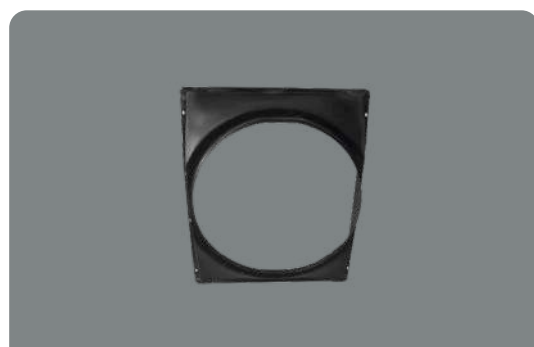

CÓD: 15732

Descrição: DEFLETOR DE RADIADOR VW TITAN 18.310
Componente: Plástico
Referência: 21O121207A



CÓD: 9157

Descrição: GUARNIÇÃO DO PARALAMA VW METEOR L.D
Componente: Plástico
Referência: 2V5821108



CÓD: 9156

Descrição: GUARNIÇÃO DO PARALAMA VW METEOR L.E
Componente: Plástico
Referência: 2V5821107

CÓD: 15738
Descrição: SUPORTE DA PLACA VW
Componente: Plástico
Referência: TAP807801





GALERIA VOLVO

lukefibroplast.com.br/produto/listar/Volvo

VOLVO NEW FH GLOBTROTTER
VOLVO FH CAB. BAIXA/ALTA
VOLVO FM CAB. BAIXA/ALTA
VOLVO VM EURO
VOLVO NEW FM
VOLVO NEW FH
VOLVO FH
VOLVO CHINÊS

VOLVO

DEFLETORES

VOLVO FH/FM 2022
VOLVO NEW FH GLOBETROTTER
EDIÇÃO ESPECIAL
VOLVO FH GLOBETROTTER
2015/16 EDIÇÃO ESPECIAL
VOLVO NEW FH
VOLVO FH CABINA BAIXA
VOLVO FM CAB. ALTA
VOLVO FM CAB. BAIXA
VOLVO NEW FM 2015 CAB. ALTA
VOLVO VM EURO V MOD. FH
VOLVO FH CAB. ALTA
VOLVO NEW FH CAB. BAIXA



QUEBRA-SOL

VOLVO VM



ANTI-FURTOS

VOLVO VM
VOLVO NEW FH 2015



PARA-CHOQUES

VOLVO VM
VOLVO NEW FH
VOLVO FH/FM
VOLVO NL/EDC
VOLVO FH CHINÊS



ESTRIBOS

VOLVO VM 270
VOLVO FH



SIDE SKIRTS

VOLVO NEW FH



GRADES

VOLVO FH 2010



DEFLETOR DE COLUNA

VOLVO NEW FH/FM



TAMPA DE BATERIAS

VOLVO FH
VOLVO NEW FH



TAMPA ESTRIBOS

VOLVO NL/EDC
VOLVO VM 2011
VOLVO NH



DIVERSOS

VOLVO VM
VOLVO VM 2014-2019
VOLVO FH 12 APÓS 2005
VOLVO NEW FH



SPOILERS

VOLVO NEW FH/FM
VOLVO FM/FH
VOLVO NL/EDC
VOLVO FH 12
VOLVO FH CHINÊS
VOLVO FH
VOLVO FH MOD. TOP CLASS
VOLVO FH/FM 2016
VOLVO NH
VOLVO VM



PARALAMAS

VOLVO CHINÊS
VOLVO NEW FH



PROTETORES

VOLVO FH
VOLVO NEW FH





01 AEROFÓLIO VLV NEW FH GLOB. PREMIUM - LAT. RETRÁTIL
COD: 26645



01 KIT TRANSFORMAÇÃO AEROFÓLIO VLV NEW FH
COD: 26655



01 KIT TRANSFORMAÇÃO CEGONHEIRO VLV NEW FH C/ TETO
COD: 26656



02 ANTI-FURTO VOLVO NEW FH 2015
COD: 19916



03 SIDE SKIRT VOLVO NEW FH 6X2 - 3500MM
COD: 23405

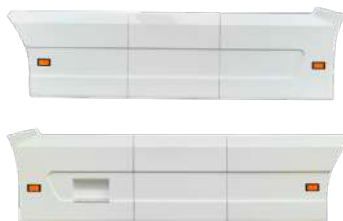

04 ALONGADOR PARALAMA VOLVO NEW FH
COD: 20235



05 SPOILER VOLVO NEW FH/ FM PREMIUM
COD: 26650



05 SPOILER VOLVO NEW FH/ FM SIMILAR AO ORIGINAL
COD: 26234



06 C.J. CPL P/ FECHAR PARALAMAS VLV NEW FH 6X2 APÓS 2022
COD: 8663





DEFLETORES

VOLVO



DEFLETORES

VOLVO



CÓD: 8043

Descrição: AEROFOLIO VLV NEW FH CAB. BAIXA ORIG. RETRÁTIL
Componente: Plástico

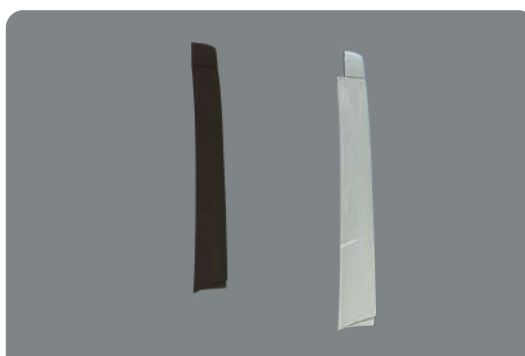

CÓD: 8044

Descrição: CEGONHEIRO VLV NEW FH CAB. BAIXA S/ TETO ORIG. FIXO
Componente: Plástico

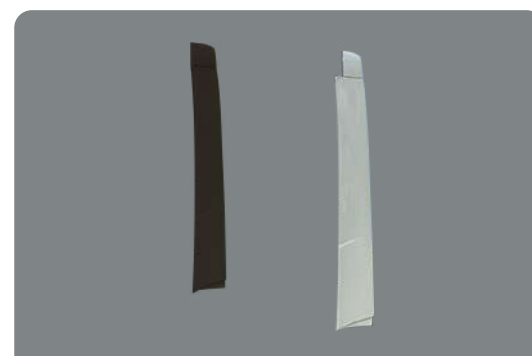

CÓD: 8045

Descrição: CEGONHEIRO VLV NEW FH CAB. BAIXA S/ TETO ORIG. RETRÁTIL
Componente: Plástico



CÓD: 16780

Descrição: AEROFÓLIO VOLVO FH CABINA BAIXA
Componente: Plástico

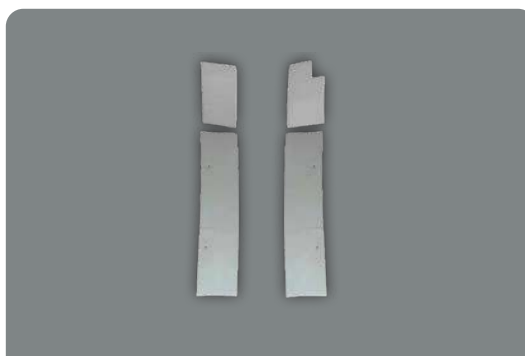

CÓD: 19910

Descrição: CEGONHEIRO VOLVO FM 2015-2021 CAB. ALTA
Componente: Plástico



CÓD: 19911

Descrição: CEGONHEIRO VOLVO FM 2015-2021 CAB. ALTA C/ TETO
Componente: Plástico



CÓD: 17256

Descrição: AEROFÓLIO VOLVO FM CAB. ALTA
Componente: Plástico



CÓD: 17255

Descrição: AEROFÓLIO VOLVO FM CAB. BAIXA
Componente: Plástico



CÓD: 19909

Descrição: AEROFÓLIO VOLVO FM 2015-2021 CAB. ALTA
Componente: Plástico



CÓD: 16076

Descrição: AEROFÓLIO VOLVO FH CABINA ALTA CPL
Componente: Plástico

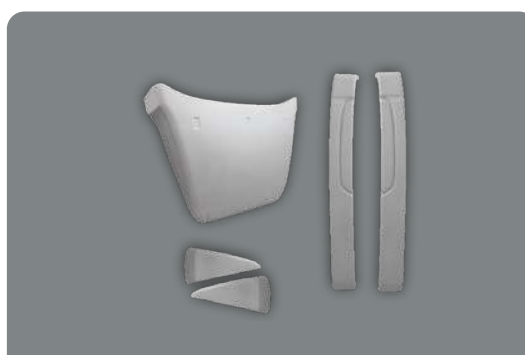

CÓD: 16080

Descrição: AEROFÓLIO VOLVO VM EURO V MOD. FH
Componente: Plástico



CÓD: 16802

Descrição: CEGONHEIRO CPL VOLVO FH CAB. ALTA C/ TETO
Componente: Plástico

DEFLETORES

VOLVO



ANTI-FURTOS



SIDE SKIRTS



/// SIDE SKIRT

VOLVO



/// DEFLETOR DE COLUNA



/// TAMPA ESTRIBOS



/// SPOILERS

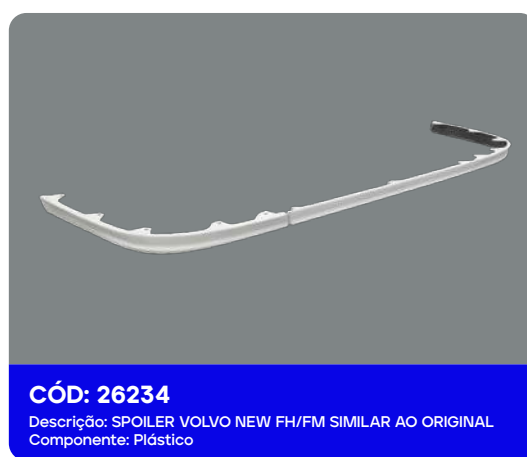

SPOILERS

VOLVO

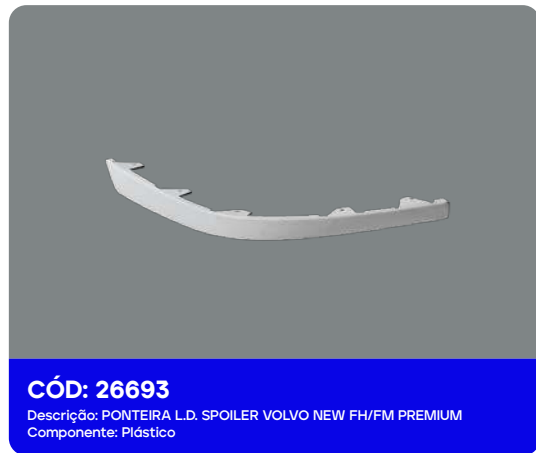

SPOILERS

VOLVO



QUEBRA-SOL



PARA-CHOQUES

VOLVO



CÓD: 6570
 Descrição: CAPA ENVOLVENTE VLV FH/FM 2022
 Componente: Plástico



CÓD: 19914
 Descrição: CAPA ENVOLVENTE VOLVO NEW FH/FM 2015-2021
 Componente: Plástico



CÓD: 17066
 Descrição: CAPA ENVOLVENTE VOLVO FH 12 ANTIGO
 Componente: Plástico



CÓD: 17944
 Descrição: CAPA ENVOLVENTE VOLVO FH CHINÊS
 Componente: Plástico



CÓD: 19438
 Descrição: PARA-CHOQUE ENVOLVENTE VOLVO NL/EDC RTM
 Componente: Fibra Injetada - RTM



CÓD: 17056
 Descrição: PARACHOQUE VOLVO VM 270
 Componente: Fibra Injetada - RTM
 Referência: 20961676



CÓD: 7302
 Descrição: MOLDURA L.D. DO PARACHOQUE VLV VM 2019 C/ FURO FAROLETE
 Componente: Plástico



CÓD: 7331
 Descrição: MOLDURA DO PARACHOQUE VLV VM 2019 C/ FURO FAROLETE
 Componente: Plástico



CÓD: 7303
 Descrição: MOLDURA L.E. DO PARACHOQUE VLV VM 2019 C/ FURO FAROLETE
 Componente: Plástico



CÓD: 5599
 Descrição: MOLDURA L.D. DO PARACHOQUE VLV VM 2014-2018 C/ FURO FAROLETE
 Componente: Plástico
 Referência: 82987667/82992302



CÓD: 5740
 Descrição: MOLDURA DO PARACHOQUE VLV VM 2014-2018 C/ FURO FAROLETE
 Componente: Plástico



CÓD: 5600
 Descrição: MOLDURA L.E. DO PARACHOQUE VLV VM 2014-2018 C/ FURO FAROLETE
 Componente: Plástico
 Referência: 82987666/82992301

ESTRIBOS

VOLVO



GRADES



TAMPA DE BATERIAS



DIVERSOS

VOLVO



CÓD: 15690

Descrição: PISANTE LATERAL VOLVO VM L.E. 2006 EM DIANTE
Componente: Plástico
Referência: 20957734

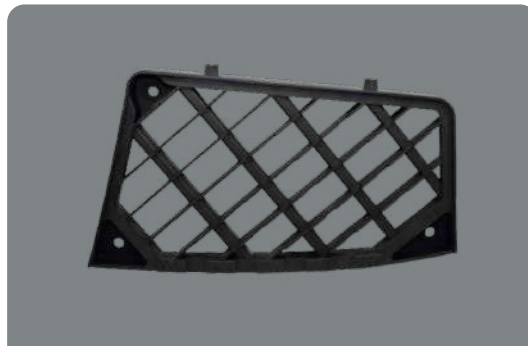

CÓD: 15691

Descrição: PISANTE LATERAL VOLVO VM L.D. 2006 EM DIANTE
Componente: Plástico
Referência: 20957735



CÓD: 15697

Descrição: TAMPA DO PARACHOQUE VOLVO VM L.D.
Componente: Plástico
Referência: 2742332



CÓD: 15698

Descrição: TAMPA DO PARACHOQUE VOLVO VM L.E.
Componente: Plástico
Referência: 2742451



CÓD: 5936

Descrição: TAMPA DO PARACHOQUE VOLVO VM 2014-2019 L.D.
Componente: Plástico
Referência: 82531174

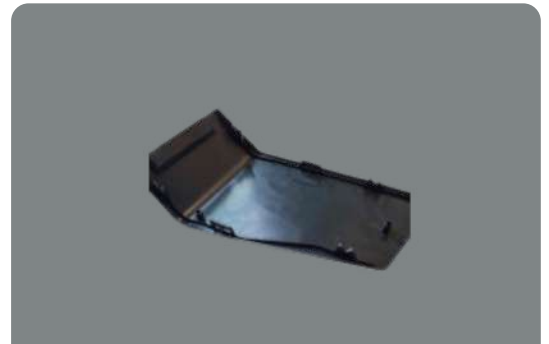

CÓD: 5937

Descrição: TAMPA DO PARACHOQUE VOLVO VM 2014-2019 L.E.
Componente: Plástico
Referência: 82524665

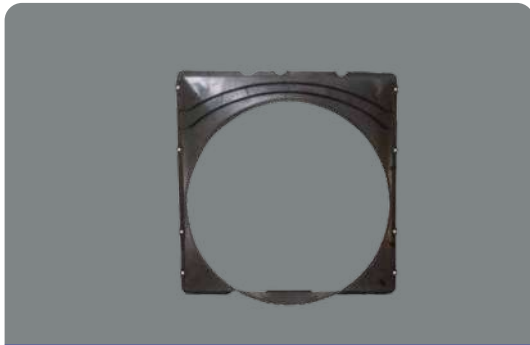

CÓD: 16342

Descrição: DEFLETOR DO RADIADOR FH 12 APÓS 2005
Componente: Plástico
Referência: 20502964

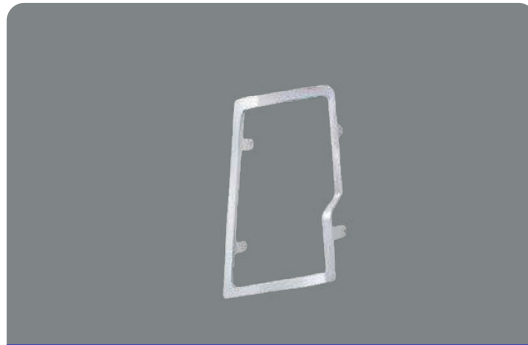

CÓD: 16352

Descrição: ARO DO FAROL L.E. FH 12 APÓS 2005
Componente: Plástico
Referência: 20452847C

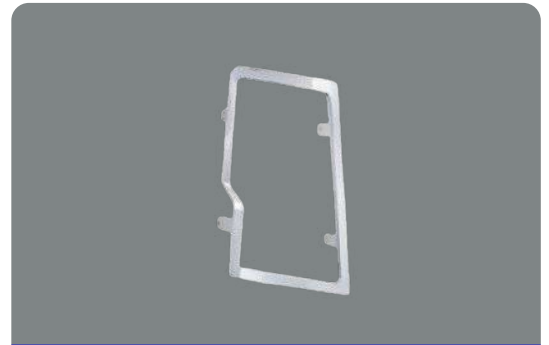

CÓD: 16351

Descrição: ARO DO FAROL L.D. FH 12 APÓS 2005
Componente: Plástico
Referência: 20452848C

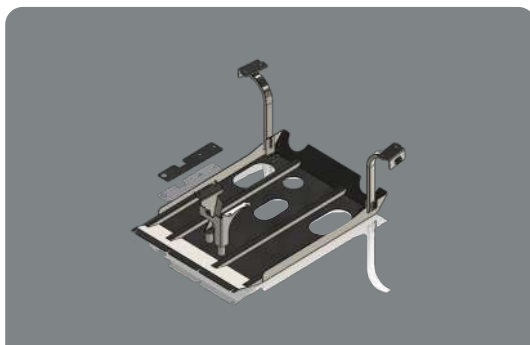

CÓD: 26369

Descrição: PROTEÇÃO DE CÁRTER VOLVO NEW FH
Componente: Ferro
Referência:

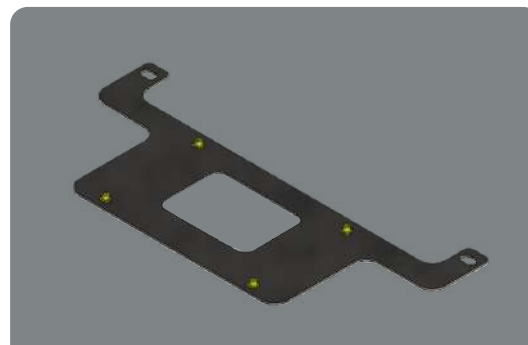

CÓD: 26377

Descrição: SUPORTE PLACA TRAS. VLV NEW FH
Componente: Ferro
Referência:

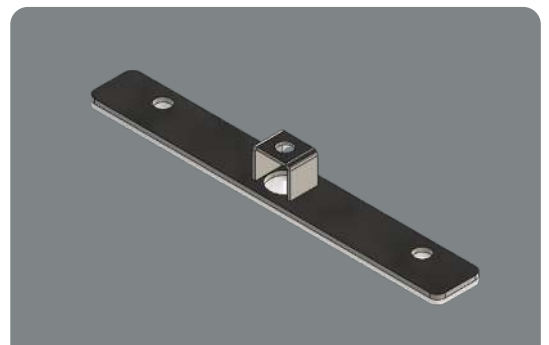

CÓD: 26378

Descrição: SUPORTE PLACA DIANT. VLV NEW FH
Componente: Ferro
Referência:

CÓD: 5952

Descrição: CALHA DE PORTA VOLVO NEW FH
Componente: Plástico



PARALAMAS

VOLVO



PROTETOR DE BOLSA DE AR/VÁLVULA





GALERIA RENAULT

lukefibroplast.com.br/produto/listar/Renault

RENAULT MASTER

RENAULT

DEFLETORES



CÓD: 17960

Descrição: AEROFÓLIO RENAULT MASTER 2014
Componente: Plástico

DEFLETORES

AEROFÓLIO RENAULT MASTER 2014



CONHEÇA NOSSO SITE / MARKETPLACE

Uma plataforma de vendas, dinâmica e completa, que possibilita atender todos os nossos diversos perfis de clientes como distribuidores, lojistas e representantes, conforme cada regra de negócio atrelado a seu perfil.

Outro destaque do nosso site, é ser um MARKETPLACE, onde nossos parceiros podem vender seus produtos aos clientes finais através da nossa PLATAFORMA. Solicite mais informações.

The image displays the Fibroplast website interface on both desktop and mobile devices. The desktop monitor shows a product launch for 'SIDE SKIRT NEW DAF XF' featuring a red DAF truck with a callout of the side skirt. Below the truck are four 'NOVO' buttons and product images. The smartphone shows the same content in a mobile view. A QR code is positioned below the smartphone.

**ALCANÇE AINDA MAIS CLIENTES
COM OS FORMATOS E CONDIÇÕES
QUE TEMOS PARA TE OFERECER.**

FIBROPLAST

LUKE GROUP

CATÁLOGO DIGITAL



FIBROPLAST

LUKE GROUP

Baixe a versão digital
disponível em nosso site.



FIBROPLAST

UMA EMPRESA
LUKE GROUP

LUKE

GROUP

FIBROPLAST

O seu jeito,
o seu caminhão.

LUKE **GROUP**

+55 49 3652 0005
0800 808 6060
www.lukefibroplast.com.br
contato@lukefibroplast.com.br

Linha Capetinga, interior
CEP 89980-000
Campo Erê - SC

  [lukefibroplast](#)

